

HCP7-F COMMISSIONING SETUP MANUAL

EX HEVAC defaults that can be user edited are as follows:

*****If these defaults & time clock region etc are suitable then there no adjustment needed.**

EX HEVAC DEFAULTS

- 1.) Current Time, Date and Daylight saving status (DLS) A.E.S.T +DLS
(Summer time start @ 1st Sunday in October, Winter time @ 1st Sunday in April)
- 2.) Number of "CO" & NO2 sensors to be connected to controller (1-42) 4 X CO , 0 X NO2
- 3.) note : CO sensor range **fixed at 0-100ppm not adjustable** 100 (suits hevac HGS-CO)
- 4.) note : NO2 sensor range **fixed at 0-20ppm not adjustable** 20 (suits hevac HGS-NO2)
- 5.) Time switch set to FORCE on fan at **100%** between the hours of **7-9am & 5-7pm** (subject to D3 & M link)
- 6.) Idle run timer set to FORCE on fan for **10** minutes at **100%** if fan hasn't started in the past **24** hours but is inhibited from starting in this mode between the hours of **10pm to 9am** (editable).
- 7.) PreSet using "CUSTOM" mode to modify "UNOCCUPIED" settings to exceed AS1668.2 requirements as per Hevac's recommendations , SEE PAGE 7.
- 8.) Close of contacts "D1 to M"= **FAN** (or vsd) **FAULT**, & Independent of R1 (fan run call) See page 3 & 20
- 9.) Y2 Output preset as a fixed 10vdc source or **NEW** > can now be set to mirror Y1 to drive up to 6 VSD's

HEVAC MAY HAVE MADE PRE COMMISSIONING CHANGES TO SUIT YOUR PROJECT BUT WILL BE NOTED BELOW

*****NEW : FAIL SAFE OUTPUTS, SEE CONNECTION
DIAGRAMS FOR REVISED CONNECTIONS*****

SPARE ME THE DETAILS : changing # of CO Sensors connected.

Generally the only item needing editing is the number of connected Hevac HGS-CO sensors. Follow the steps below to simply edit this value.

- 1.) Press the **ENTER** button to display the 1st menu : **SET CLOCK**
- 2.) Press the **DOWN** button till **CONFIGURE CONTROLLER** menu is displayed. press **ENTER**.
- 3.) Using the **UP, DOWN & ENTER** buttons enter the password number "**9562**", press **ENTER**.
- 4.) **SET NUMBER OF SENSORS** menu will be displayed, press **ENTER**.
- 5.) **Number of CO Sensors** will be displayed & showing existing quantity (ex factory = 4)
- 6.) Use the **UP** or **DOWN** buttons to edit quantity of connected CO sensors , press **ENTER**.
- 7.) **Number of NO2 Sensors** will be displayed (ex factory = 0), press **ENTER** to accept.
- 8.) Press the **ESC**(ape) button to exit programming & resume normal automatic control.

PAGE INDEX

<u>DESCRIPTION</u>	<u>PAGE</u>
DEFAULT SETTINGS EX FACTORY	1.)
INDEX.....	2.)
COMMISSIONING & TESTING PROCEDURE.....	3.)
FAULT DIAGNOSIS.....	4.)
HEVAC SENSOR CALIBRATION WITH CALIBRATED GAS.....	5.)
OPERATIONAL NOTES.....	6.)
AS1668.2-2012 COMPLIANCE INFORMATION.....	7.)
INPUT / OUTPUT RESPONSE INFORMATION CHART.....	8.)
KEYBOARD FUNCTIONS, DISPLAYS & TERMINAL DESIGNATIONS.....	9.)
CONTROLLER MAIN MENU BASIC DECRPTION.....	10.)
SET CLOCK.....	11.)
SET (OPTIONAL USE) TIME SWITCH.....	11.)
VIEW EVENT DATA LOGGER.....	13.)
CONFIGURE CONTROLLER via SUB MENUS (password protected).....	14-21.)
-SET NUMBER OF SENSORS	-# of CO sensors , # of NO2 sensors
-SET OCCUPANCY TYPE	-Unoccupied, Occupied, Custom (> <u>various sub menus</u>)
-EDIT OUTPUT DELAY TIMERS	-Delay on & run on timer settings per relay
-SET AVERAGING TIME WINDOW	-Sensor averaging time window TWA
-SET IDLE PERIOD FAN RUN TIMER	-Set delay for forced ventilation & run for time
- SET D1 FAULT STATE	-Set D1 fault input as N/O or N/C & interlocked with fan run Y/N
-EDIT FORCED FAN RUN SPEED	-Speed setting for forced fan run override
-Y2 APPLICATION	-Set Y2 as fixed 10vdc source or mirror Y1
-CONFIGURE MODBUS	-RS485 modbus comms settings
-RESTORE FACTORY DEFAULTS	-Clear memory & return controller to defaults
EXAMPLE CONNECTION ELECTRICAL DRAWINGS.....	22-24.)

RECOMMENDED COMMISSIONING & TESTING PROCEDURE

GENERAL NOTES :

Once the system has been powered & the number & type of connected sensors has been correctly programmed into the controller - see page 1 (SPARE ME THE DETAILS), If the system is wired correctly, the controller should after a one minute power / warm up period, be sitting in idle mode.

If a fault mode exists for any reason the controller will after a one minute delay, go into alarm mode and display the particular fault that will need to be addressed before proceeding with system testing & commissioning ie : if for example a sensor connected to the HCP7 controller input terminal "X4" has been wired incorrectly and not delivering at least a 2vDC output signal to the controller (in reference to the system common neutral), after a one minute delay, the controller will alarm and display a sensor fault message for sensor 4. Mute the alarm via the remote push button switch connected to terminals "D2"&"M" or use the top right hand button on the controller labeled MUTE.

Also note : Ex factory, the fan fault input "D1" is set as a N/O input that closes on fault, if a N/C fault circuit is used (ie to suit air proofing pressure switches or C.T's) this setting will need to be changed in programming - see page 20.

The D1 fault input can be programmed to be interlocked or not with the fan run relay R2 (the default is Not Interlocked). Being interlocked with R2 is a typical requirement if using N/O (=fan fault) such as using an air pressure proving pressure switches or a C.T for fan fault indication such that a N/O input is only seen as a fault when the fan should be producing pressure.

INITIAL CHECKS (black text basic instruction , blue expanded explanation)

1.) Using a volt meter, check the controller is receiving 24 volts power supply .

The HCP7 controller & HGS sensors will operate with either a 24v DC or AC supply. The power supply **ACTIVE** wire should be connected to the HCP7 "+" power supply terminal, and the **NEUTRAL** to the controllers "-" terminal. Also verify that the wires being used as the 24v active & neutral supply are also correctly connected to the appropriate terminals on the HGS sensors ..crossed 24V power supply wires between the controller & sensors can in time cause damage to the components and will cause incorrect operation. The power supply neutral wire needs to be connected to the HGS sensors "GO" terminals, and the active to the "G" terminals. The sensor output terminal "Y" will then produce a **2-10vDC** measured in reference to the power supply (AC or DC) NEUTRAL (GO) and is relative to 0-100 ppm of CO .

2.) Verify with a volt meter (set to the 20 volts DC scale) that at least 2.0volts DC is being received on all HCP7 controller used "X" input terminals (red meter lead on an "X" input terminal and the black lead on any "M" or "-" terminal ("M's" & "-" are internally connected).

2.0 volts DC = 0 ppm CO & every 0.8 volts DC above that equates to +1ppm, ie : 2.40vDC = 5 ppm. Sensor inputs must be connected in sequence without gaps ..ie 4 connected CO sensors would be connected to input terminals - X1, X2, X3 & X4. The number of programmed sensor inputs must have physical connections otherwise a sensor fault will be set. CO sensors need to be connected before any NO2 sensors.

3.) Pressing the "STATUS" button on the HCP7 controller will show current status of connected inputs and outputs in a series of pages that are accessed by further pushing of the STATUS button. Check that the values & status of the I/O are as expected and are inline with the physical inputs & outputs. The 1st status screen shows the highest CO & NO2 inputs BUT in Time Weighted Average (TWA) reading - meaning the inputs are read & averaged over a settable time window - see page 5. The next page shows the actual current values for each sensor , followed by the output status of the relays etc.

4.) Press the "TEST" button on the HCP7 which demonstrates & tests the controllers

output response using a virtual sensor input automatically raising from 0 to 60 ppm CO and returning to 0 over a 5 minute period. For the sake of reduced demo time, most delay times during the test are bypassed and the outputs will respond to the pre-programmed default CO ppm trigger values with minimal delay. Exceeding 9ppm, the Relay 2 fan enable relay, will energise and the vsd or fan should start. As the virtual input increases past 20 ppm, if a VSD is connected to the controllers "Y1" terminal, the VSD should ramp up until maximum speed as the virtual CO input reaches 35 ppm. After this input reaches 55ppm the alarm strobe output should energise (relay R3) and at 60 ppm the siren output will energise (relay R4). Test that the siren can be muted with the site installed momentary "SIREN MUTE" push button (connected between HCP7 terminals "M & D2").

The virtual input will then proceed to slowly return to 0ppm and relative outputs should de-energise in sequence until the controller returns to the idle state and the test automatically ends . This test can also be canceled any time during the test by again pressing the TEST button.

OTHER OPTIONAL SYSTEM COMMISSIONING CHECKING

Sensors are supplied factory calibrated and shouldn't need checking with calibration gas during initial site commissioning & testing, but if desired follow the procedure on page 5 to check for correct output per 0 & 100ppm CO. It is recommended to have the sensors calibrated every 12 months after commissioning. To aid in testing & fault finding, Hevac HGS-CO sensors are equipped with a basic output indication yellow flashing led to help identify in the field which sensor is producing an output or is in fault condition. The sensor also incorporates a very handy on-board test pin header to aid in field testing the sensor wiring & the HCP7 controllers ability to correctly respond to two different fixed sensor output levels. Beneath the HCP7 connection terminal strip is a 3 way pin header, using the supplied 2 way jumper (which in normal operation is only connected to one pin & having no effect) short the middle & left pins to produce a fixed output level equating to ~ 35ppm CO, which will cause the HCP7 to energise (after 1 minute) the R2 fan enable relay to start the fan or VSD, and will in then ramp up the VSD (if installed) to full speed.

If the jumper is fitted to the middle & right pins, a full sensor output level equivalent to over 100ppm (11vdc) will be produced which the controller will see as a fault condition resulting in (after a minutes delay) full fan speed and to put the outputs into alarm mode.

Relay 5 (terminal 8) is available for use as a normally energised relay if no faults exist for optional use as a system healthy indication lamp.

FAULT DIAGNOSIS

1.) If the VSD doesn't respond correctly during the test, 1st check that its getting an on/off enable signal from the HCP7's FAN enable relay R2. If whilst the controller is producing a modulating output signal to increase the VSD speed and the VSD doesn't ramp up, verify that the controller is producing a 0-10vdc signal on its "Y1" output terminal by 1st removing the site wire from terminal "Y1" and rerun the HCP7 TEST (button) and test if a 0-10vdc output is being produced between the controllers "Y1"(DC+) & "M" (GND)" terminals, if it does and the drive wasn't responding, check the field wiring between the HCP7 "Y1" output to the VSD "+" signal input, and the HCP7 "M" (or 24v neutral) to VSD signal ground. Also check the settings in the VSD, ie it is set to recieve a voltage signal input not 4~20mA current input~which is a common error.

- 2.) If the siren or strobe outputs doesn't respond, check the relative HCP7 output relays (R3 & 4) are closing & check the field wiring - the MLD95A alarm module black wire is its neutral connection , the white wire energises the strobe & the red wire energises the siren.
- 3.) If the external Mute button doesn't mute the siren whilst in alarm mode, check that the switch can provide a voltage free momentary closed contact to the controllers terminals "D2 & M".
- 4.) If more then 7 sensors are fitted to the system, expansion modules type EXP7 will be fitted that allow 7 more sensors with each expansion module fitted. These sensor inputs should also appear in the status screen pages on the HCP7, if not check that the expansion comms link "E & M" is connected to all modules. Address links also need to be wired in each EXP7 expansion modules if more then one EXP7 module is installed as follows:

1 x expansion module ..no address links required	(= up to 14 sensors)
on 2nd expansion modules fit link from M to D1	(= up to 21 sensors)
on 3rd expansion modules fit link from M to D2	(= up to 21 sensors)
on 4th expansion modules lfit ink from M to D1 & D2	(= up to 28 sensors)
on 5th expansion modules fit link from M to D3	(= up to 35 sensors)
on 6th expansion modules fit link from M to D1& D3	(= up to 42 sensors)

HEVAC HGS-CO SENSOR CALIBRATION WITH CALIBRATION GAS.

REQUIRED EQUIPMENT:

- 1 X CARBON MONOXIDE GAS BOTTLE CALIBRATED TO 0 ppm (STILL WITHIN USED BY DATE)
- 1 X CARBON MONOXIDE GAS BOTTLE CALIBRATED TO 100 ppm (STILL WITHIN USED BY DATE)
- 1 (At Least) X GAS BOTTLE REGULATOR C/W TUBING & FLOW HEAD TO FIT SENSOR HEAD
- 1 X ELECTRONIC VOLT METER SET TO 20vDC SCALE

CALIBRATION STEPS :

- 1.) **REMOVE SENSOR COVER AND LOCATE "ZERO" & "GAIN" POTENTIOMETERS ON PCB.**
- 2.) **CONNECT / HOLD VOLT METER PROBES TO MEASURE THE SENSOR OUTPUT. CONNECT THE METER'S BLACK LEAD TO TERMINAL "GO" AND THE RED LEAD TO "Y".**
- 3.) **USING THE "0ppm" GAS BOTTLE & REGULATOR ATTACH FLOW HEAD SNUGLLY OVER CO SENSOR HEAD, LOCATED PROTRUDING BOTTOM RIGHT OUT OF THE HGS HOUSING.**
- 4.) **OPEN THE REGULATOR ON THE "0ppm" GAS BOTTLE AND LEAVE TO SETTLE MEASUREMENT FOR 15 SECONDS, NOTE VOLTAGE OUTPUT.**
- 5.) **AJUST THE "ZERO" POTENTIOMETER WITH A SMALL FLAT HEAD SCREW DRIVER UNTIL THE VOLTAGE O/P READS 2.00 +/- 0.02 Volts. (2-10vDC O/P =0 to100 ppm with 0.08 volts per1ppm) 5.) CLOSE THE REGULATOR ON THE "0ppm" BOTTLE AND CONNECT THE "100ppm" GAS BOTTLE AND REGULATOR.**
- 6.) **OPEN THE REGULATOR ON THE "100ppm" GAS BOTTLE AND LEAVE FOR 30 SECONDS OR UNTIL MEASUREMENT SETTLES, NOTE VOLTAGE OUTPUT.**
- 7.) **ADJUST "GAIN" POTENTIOMETER SUCH THAT THE O/P VOLTAGE READS 10.00 +/- 0.02 Volts**
- 8.) **TURN OFF REGULATOR AND REPLACE SENSOR HOUSING LID.**
- 9.) **ATTACH A NEW CALIBRATION STICKER TO HOUSING SHOWING NEXT DUE CALIBRATION DATE AND IDENTIFICATION OF THE SERVICE TECHNICIAN & COMPANY.**



Operational notes

"TIME WEIGHTED AVERAGE" (TWA) is a method used to average out sensor readings to produce an average output value calculated over a set period (time window), whereas "CURRENT VALUE" (CV) produces the actual current real time sensor value. To save energy & meet minimum safety requirements AS1668.2 calls up the use of TWA measured over an 8 hour period, Most CO control systems on the market tend to ignore this and can only respond to current value (which exceeds requirements but uses more energy). This controller can be set to use any combination of TWA or CV for the various outputs. By default ex Hevac, we use the custom menu to set all outputs to use current value (CV). The controller can also be set to force ON fan operation between several configurable blocks of time, intended for use when known high periods of traffic are expected and to save cycling and fume build up. The controllers internal time switch is factory preset to force fan operation Monday to Friday in the morning between 7am till 9am and in the evening between 5pm till 7pm (but is adjustable). **To enable** this feature, an external **link** or switch must also be **connected** between terminals **"M" & "D3"**. This input can alternatively be used as a forced fan run input (for example) from a switch, a movement sensor (with built in run on timer) or & a thermostat, this forced fan run "speed" is also programmable with a factory default of 100% vsd or high speed. The controller also makes use of an "Idle Run Timer" routine that keeps track of the last fan operation time and automatically starts the fan to satisfy minimum ventilation requirements. The preset factory settings force fan ON operation after 24 hours of idle time and then to run for 10 minutes , both gap & duration settings are user adjustable. HEVAC have also included a feature to inhibit this forced ON operation by use of another internal time switch, which blocks the Idle Timer triggering fan operation between certain hours so as not to cause unnecessary noise (for example) during night hours in an apartment building. The factory settings for this inhibit timer is to block operation between the hours of 10pm till 9am , Note : This inhibit routine does not stop a genuine fan start call due to a build up of CO or NO2 which is enabled to operate 24/7 as per AS1668.

The number of connected sensors is user adjustable in the menu system under the password protected " CONFIGURE CONTROLLER " sub menu. The password is **9562**.
Leave unused X & D inputs open.

Analog output "Y2" is factory preset as a 10vDC output signal source for use (as example) as a EC fan full speed signal source via a "Auto/Manual" selector switch or for use as a sensor I/P test = full scale. As of Jan. 2020 this Y2 output can now also be set to mirror the output of Y1 where more then 3 vsd's need to be driven (each Y output can drive 100mA = ~ 3 typical VSD's).

This controller has a simple time stamped data logger to help diagnose faults and system behavior. Also for optional use, Relay 5 acts as an "I'm OK" output which holds relay 5's contacts closed (on) when the controller has power, is operating correctly, there are no sensor faults and no interlocked fan faults. **The fan fault input "D1"** can also be user set such that the controller will respond to an opening contact (N/C) or closing contact (N/O) contact (default) to "M" on fan fault and whether the fault input is internally interlocked with the fan run relay.

Relay 5 (terminal 8) is available for use as a normally energised relay if no faults exist & controller has power for connection to an optional system healthy lamp.

AS1668.2 - 2012 COMPLIANCE

*****NOTE ***: AS1668.2-2012 Calls for CO ppm sensor response to be based on a Time Weighted Average (TWA) set over an 8 hour period, and with different O/P ppm trigger values depending on the space being used as an occupied or unoccupied CarPark.** Hevac has found that although the specified settings for unoccupied carparks satisfy the health & safety standards and conserve energy, they give poor comfort response to sudden build up of annoying fumes from an idling car or forklift etc, So as a reasonable compromise, Hevac has preset the HCP7 controller to exceed the AS1668.2 requirements, using the controllers "CUSTOM" programming menu to set all outputs as "CV". The **Fan Enable** relay (R2) triggers at 15ppm CO with a 1 minute ON delay, the **VSD ramp** to start from 20ppm & ramp to 35ppm CO (or if 2 speed on/off control selected the **High speed** relay to energize at 35ppm & off at 20ppm), the **Strobe** light O/P set to 55ppm CO as an early warning of high CO contaminants & the Audible Alarm O/P's set to trigger at 60ppm CO. The site commissioning technician can change most settings (with the custom menu) or select one of the inbuilt preset occupied or un-occupied programs that fully comply to the standards, but compliance to meet minimum standards then shifts from HEVAC to the programmer. **Note** : AS1668.2-2012 no longer calls up the use of NO2 sensors, although HEVAC still recommends their system inclusion particularly when many diesel trucks or cars use the parking facilities. The "CONFIGURE" menu for editing is password protected, the password (is the 1st 4 digits of our phone number) **9562**. A 3rd party Modbus connected monitoring / data logging module c/w web interface is also available if required, although the controller does now include a simple 20 event data logger inbuilt. The standards call for the maximum distance between sensor locations not to exceed 25 meters with sensors mounted between 750mm & 1800mm above floor level. Please refer to the standards for other criteria that affect system compliance. **Relay 5 (terminal 8) is available for use as a normally energised relay if no faults exist & controller has power, for connection to external fail mode interlocks or & system healthy indication.**

IT SHOULD BE NOTED THAT THE CODE DOESNT ACTUALLY CALL UP THE REQUIREMENT OF A STROBE LIGHT , THIS HAS BEEN A TRADITION THAT CONTROL SUPPLIERS HAVE ALSO SUPPLIED AND SET TO TRIGGER AS AN EARLY WARNING BEFORE THE REQUIRED SIREN TRIGGER POINT IS REACHED.

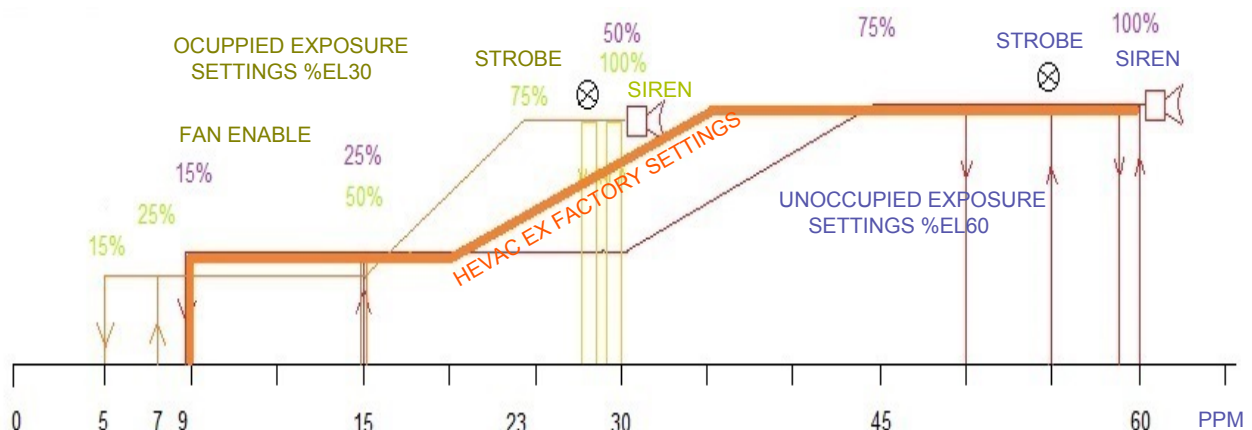

NOTE: THE CODE ALSO CALLS UP FORCED RUNNING OF THE FAN SYSTEM TO MEET MINIMUM VENTILATION REQUIREMENTS IN A 24HR PERIOD. AS SUCH THE HCP7 INCLUDES AN IDLE TIMER THAT TRIGGERS FAN OPERATION FOR 10 MINUTES (ADJUSTABLE) IF THE FAN SYSTEM HASNT STARTED IN THE PREVIOUS 24HRS (ADJUSTABLE).



*** NOTE : THE CONTROLLER IS DELIVERED PRESET USING SETTINGS FROM THE "CUSTOM" MENU AS PER HEVAC RECOMMENDATIONS & EXCEED AS1668.2 REQUIREMENTS NO2 SETTINGS ARE BASED ON HEVAC RECOMMENDATIONS.**

UNOCCUPIED MODE FACTORY FIXED SETTINGS (using 8Hr TWA) (as per AS1668.2)

FIXED PRESET SETTINGS FOR 2 SPEED FAN OUTPUT (LOW / HIGH)

RELAY 2 TWA LOW SPEED ON > 15 ppm OFF < 9ppm CO / ON > 2ppm OFF <1.5ppm NO2 / 1 Min. ON DELAY/ 5 Min OFF DELAY
 RELAY 1 TWA HIGH SPEED ON > 45 ppm OFF < 30ppm CO / ON > 3ppm OFF < 2.5ppm NO2 / 2 Min. ON DELAY/ 5 Min OFF DELAY
 RELAY 3 TWA STROBE ON > 55 ppm OFF < 50ppm CO / ON > 3.5ppm OFF <3ppm NO2 / 1 Min. ON DELAY
 RELAY 4 TWA SIREN ON > 60 ppm OFF < 55ppm CO / ON > 4ppm OFF < 3ppm NO2 / 4 Min. ON DELAY

FIXED PRESET SETTINGS FOR VSD CONTROLLED FANS

RELAY 2 TWA VSD ENABLE ON > 15 ppm OFF < 9ppm CO / ON > 2ppm OFF < 1.5ppm NO2 / 1 Min. ON DELAY/ 5 Min OFF DELAY
 Y1 0-10v TWA VSD RAMP 100% > 45 ppm - Min < 30 ppm CO / 100% >3ppm - Min < 2ppm NO2 / + Integral time = 60 Minutes
 RELAY 1 TWA ON > 60 ppm OFF < 55ppm CO / ON > 3ppm OFF < 2.5ppm NO2 / 2 Min. ON DELAY/ 5 Min OFF DELAY
 RELAY 3 TWA STROBE ON > 55 ppm OFF < 50ppm CO / ON > 3.5ppm OFF < 3ppm NO2 / 1 Min. ON DELAY
 RELAY 4 TWA SIREN ON > 60 ppm OFF < 55ppm CO / ON > 4ppm OFF < 3ppm NO2 / 4 Min. ON DELAY

OCCUPIED MODE FACTORY FIXED SETTINGS (using 8Hr TWA) (as per AS1668.2)

RELAY 2 TWA LOW SPEED ON > 9 ppm OFF < 7ppm CO / ON > 2ppm OFF <1.5ppm NO2 / 1 Min. ON DELAY/ 5 Min OFF DELAY
 RELAY 1 TWA HIGH SPEED ON > 23 ppm OFF < 15ppm CO / ON > 3ppm OFF < 2ppm NO2 / 2 Min. ON DELAY/ 5 Min OFF DELAY
 RELAY 3 TWA STROBE ON > 28 ppm OFF < 26ppm CO / ON > 3.5ppm OFF < 3ppm NO2 / 1 Min. ON DELAY
 RELAY 4 TWA SIREN ON > 30 ppm OFF < 28ppm CO / ON > 4ppm OFF < 3ppm NO2 / 4 Min. ON DELAY

FIXED PRESET SETTINGS FOR VSD CONTROLLED FANS

RELAY 2 TWA VSD ENABLE ON > 9 ppm OFF < 7ppm CO / ON > 2ppm OFF < 1.5ppm NO2 / 1 Min. ON DELAY/ 5 Min OFF DELAY
 Y1 0-10v TWA VSD RAMP 100% > 23 ppm - Min < 15 ppm CO / 100% >3ppm - Min < 2ppm NO2 / + Integral time = 60 Minutes
 RELAY 1 TWA ON > 30 ppm OFF < 28ppm CO / ON > 3ppm OFF < 2.5ppm NO2 / 2 Min. ON DELAY/ 5 Min OFF DELAY
 RELAY 3 TWA STROBE ON > 28 ppm OFF < 26ppm CO / ON > 3.5ppm OFF < 3ppm NO2 / 1 Min. ON DELAY
 RELAY 4 TWA SIREN ON > 30 ppm OFF < 28ppm CO / ON > 4ppm OFF < 3ppm NO2 / 4 Min. ON DELAY

*** CUSTOM MODE EX HEVAC DEFAULT SETTINGS (exceeds AS1668.2)**

FIXED PRESET SETTINGS FOR 2 SPEED FAN OUTPUT (LOW / HIGH)

RELAY 2 CV LOW SPEED ON > 15 ppm OFF < 9ppm CO / ON > 2ppm OFF < 1.5ppm NO2 / 1 Min. ON DELAY/ 5 Min OFF DELAY
 RELAY 1 CV HIGH SPEED ON > 35 ppm OFF < 20ppm CO / ON > 3ppm OFF < 2.5ppm NO2 / 2 Min. ON DELAY/ 5 Min OFF DELAY
 RELAY 3 CV STROBE ON > 55 ppm OFF < 50ppm CO / ON > 3.5ppm OFF < 3ppm NO2 / 1 Min. ON DELAY
 RELAY 4 CV SIREN ON > 60 ppm OFF < 55ppm CO / ON > 4ppm OFF < 3ppm NO2 / 4 Min. ON DELAY

FIXED PRESET SETTINGS FOR VSD CONTROLLED FANS

RELAY 2 CV VSD ENABLE ON > 15 ppm OFF < 9ppm CO / ON > 2ppm OFF < 1.5ppm NO2 / 1 Min. ON DELAY/ 5 Min OFF DELAY
 Y1 0-10v CV VSD RAMP 100% >35 ppm - Min < 20ppm CO / 100% >3ppm - Min < 2ppm NO2 / + Integral time = 60 Mins.
 RELAY 1 CV ON > 60 ppm OFF < 55ppm CO / ON > 3ppm OFF < 2.5ppm NO2 / 2 Min. ON DELAY/ 5 Min OFF DELAY
 RELAY 3 CV STROBE ON > 55 ppm OFF < 50ppm CO / ON > 3.5ppm OFF < 3ppm NO2 / 1 Min ON DELAY
 RELAY 4 CV SIREN ON > 60 ppm OFF < 55ppm CO / ON > 4ppm OFF < 3ppm NO2 / 4 Min. ON DELAY

*****CHANGING EX HEVAC SETTINGS SHIFTS RESPONSABILITY FOR COMPLIANCE TO AUSTRALIAN STANDARDS FROM HEVAC TO THE COMMISSIONING PERSONAL***. Using "CUSTOM" mode most settings are user adjustable.**

NOTE : UNDER VSD CONTROL, RELAY 1 INTERNALLY TAKES SAME AS ON RELAY 4 TRIGGER SETTINGS AS AN OPTIONAL EXTRA ALARM OUTPUT. WE ADVISE TO USE THIS RELAY AS A FAIL SAFE RUN CALL TO THE VSD.

Keypad, displays & settings.

The controllers fascia includes 4 push buttons , a 2x16 character LCD screen and five L.E.D's indicating Low & High fan speeds, Strobe and Siren operation, and a common Fault, Demo (led flashes) & system OK led. The controllers 4 push buttons have the following functions:

"**MENU/ENTER**" : To edit the controllers settings, press this button to enter the controllers menu list (some menus are password protected).

"**MUTE / ESC**" : Used to exit a menu or as a Siren Mute, (which can also be muted by an external push button connected between terminals M and D2).

"**TEST / UP**" : pressing the "TEST" button causes normal operation to stop and a 5 minute demo/test program to run that simulates CO levels increasing from 0ppm to 63ppm & returning to 0 to demonstrate the effect on outputs and displays at various CO levels, note normal delay times are bypassed or reduced.

"**STATUS / DOWN**" : pushing the "STATUS" button causes the display to show input and output status .Push the up or down buttons to see all pages of information.

TECHNICAL DETAILS

POWER CONSUMPTION USING 24vAC	@ 10 VA (MAX)	COLOUR	GREY
"	"	MATERIAL	POLYCARBONATE
	24vDC @ 400mA	UV STABILISED	YES
MAX Y1 (VSD O/P) PERMISSIBLE LOAD	1 mA (>10K ohm)	FIRE RETARDANT	YES
MAX SENSOR INPUT CURRENT	0.07mA (Typically 0.02)	SIZE	L105 X W105 X D60mm
6 MODULE DIN MODULE ENCLOSURE			

TERMINAL DESIGNATIONS

X1	GAS SENSOR INPUT 1	
X2	"	2
X3	"	3
X4	"	4
X5	"	5 or MODBUS "A"
X6	"	6 or " " "B"
X7	"	7 or " " comms shield
M	GROUND TERMINAL	
D1	FAN FAULT INPUT (can be set as open or close on fault)	
D2	SIREN MUTE P.B INPUT	
D3	ENABLE T/Sw. interlocked FORCED FAN RUN	
D4	2 SPEED NOT VSD FAN OPERATION	
E	LOCAL BUS COMMS (to expansion module)	
M	GROUND TERMINAL	

- 12-24v NEUTRAL / GROUND
- + 12-24v ACTIVE (AC or DC)
- 1 COMMON for RELAYS 1 & 2
- 2 RELAY 1 N/C HIGH SPEED (FAIL SAFE)
- 3 RELAY 1 N/O
- 4 RELAY 2 N/O- LOW SPEED
- 5 COMMON for RELAYS 3, 4 & 5
- 6 RELAY 3 N/O- STROBE
- 7 RELAY 4 N/C- SIREN (FAIL SAFE)
- 8 RELAY 5 N/O- I'M OK= CLOSED
- M GROUND TERMINAL
- Y1 VSD 0-10vDC OUTPUT FIXED 10vDC
- Y2 or MIRROR Y1

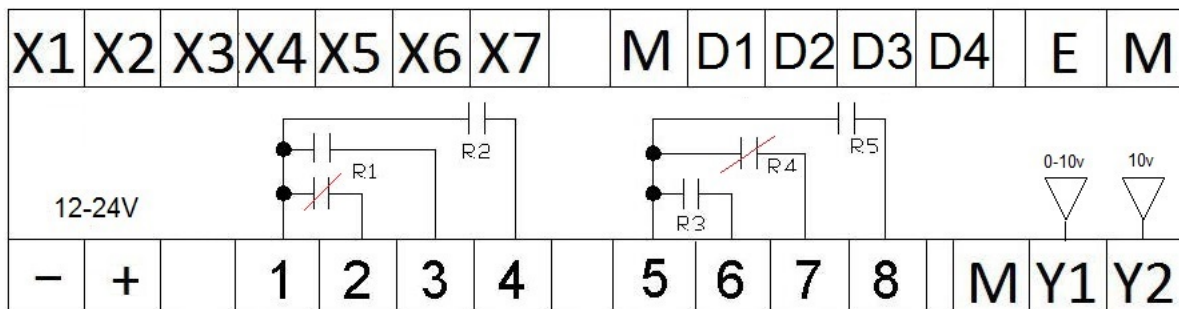

MAIN MENU

PRESS  to enter main menu to alter settings, Use  or  to scroll up or down through menus.

Under menu called SET CLOCK- SET SYSTEM CLOCK, DATE & DAYLIGHT SAVING

Under menu called SET TIME SWITCH- SET TIMES & DAYS that allow the D3 & M link to
(for D3 FAN RUN) force fan run operation.

Under menu called VIEW EVENT ON HISTORY- VIEW EVENTS that trigger an output "ON" response
UPTO 20 EVENTS RECORDED THAT OVER WRITE OLDEST RECORD

Under menu called CONFIGURE CONTROLLER-

NOTE : this menu is password protected.

P/W= 9562

- 1.) SET NUMBER OF SENSORS
 - # of CO sensors
 - # of NO2 sensors

- 2.) SET OCCUPANCY TYPE
 - occupied : loads settings to suit occupied mode
 - unoccupied : loads settings to suit unoccupied mode
 - custom : allows user to manually set most settings

- 3.) EDIT OUTPUT DELAY TIMERS
- 4.) SET AVERAGING TIME WINDOW TWA
- 5.) SET IDLE PERIOD AUTO FAN RUN TIMER
- 6.) SET D1 (fan) FAULT MODE STATE
- 7.) EDIT FORCED FAN D3/IDLE SPEED
- 8.) Y2 APPLICATION
- 9.) CONFIGURE MODBUS
- 10.) RESTORE FACTORY DEFAULTS

SET CLOCK (factory preset with eastern standard +daylight saving trigger dates)

From the running screen press the **ENTER** button to display the 1st main sub menu "**SET CLOCK**" to check or edit the controllers time, date and day light saving enable or disable settings. Daylight saving (if enabled) starts on the 1st Sunday in October (at 2am) and finish on the 1st Sunday in April (3am)

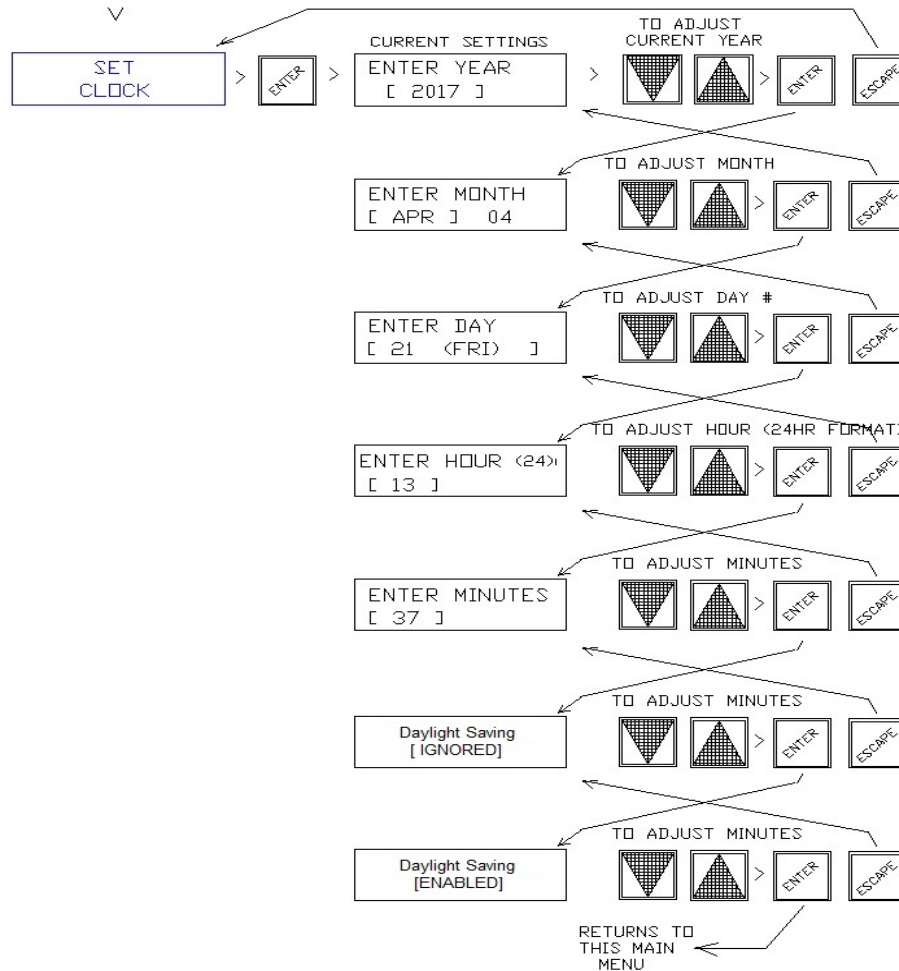

SET TIME SWITCH for D3 (INTERLOCK) FAN RUN

The controllers internal time switch to force ON fan operation (enabled by also fitting a link between terminals D3 & M) can be easily programmed for multiple ON/OFF switching times per day. The controller comes factory preset for forced fan ON operation to cover the typical peak traffic times for morning & evening - monday to friday from 7am (event 01) till 9am (event 02) & from 17:00pm (event 03) till 19:00 (event 04). This application requires a permanent link to be fitted between terminals D3 & M.

SET TIME SWITCH for D3 FAN RUN CONTINUED

To edit settings, from the normal running screen, Press the fascia button labeled “**ENTER**”. Scroll down through the menu tree with the “**DOWN**” arrow button till “**SET TIME SWITCH for D3 FAN RUN**” is displayed. Press the “**ENTER**” button to open this menu. The existing detail for switching event 1 is displayed. Unlike other time switches, this controller has very flexible unassigned switching events (instead of fixed sequential ON then OFF routines). Time switching events can be set to switch (change state) at any time & day/s, and set as a switching ON event or OFF event. With this method, multiple ON / OFF events can be set on individual days or groups of days (crossing midnight is no issue). 18 switching events are available.

Alternatively the D3 & M link can be used as an external manual forced fan ON input from some other device, ie manual switch, thermostat or a movement sensor (c/w built in run on timer). It can be interlocked with time switch times to allow external forced operation during programmed times or if no time switch OFF time entered the external interlock can trigger operation as required 24/7.

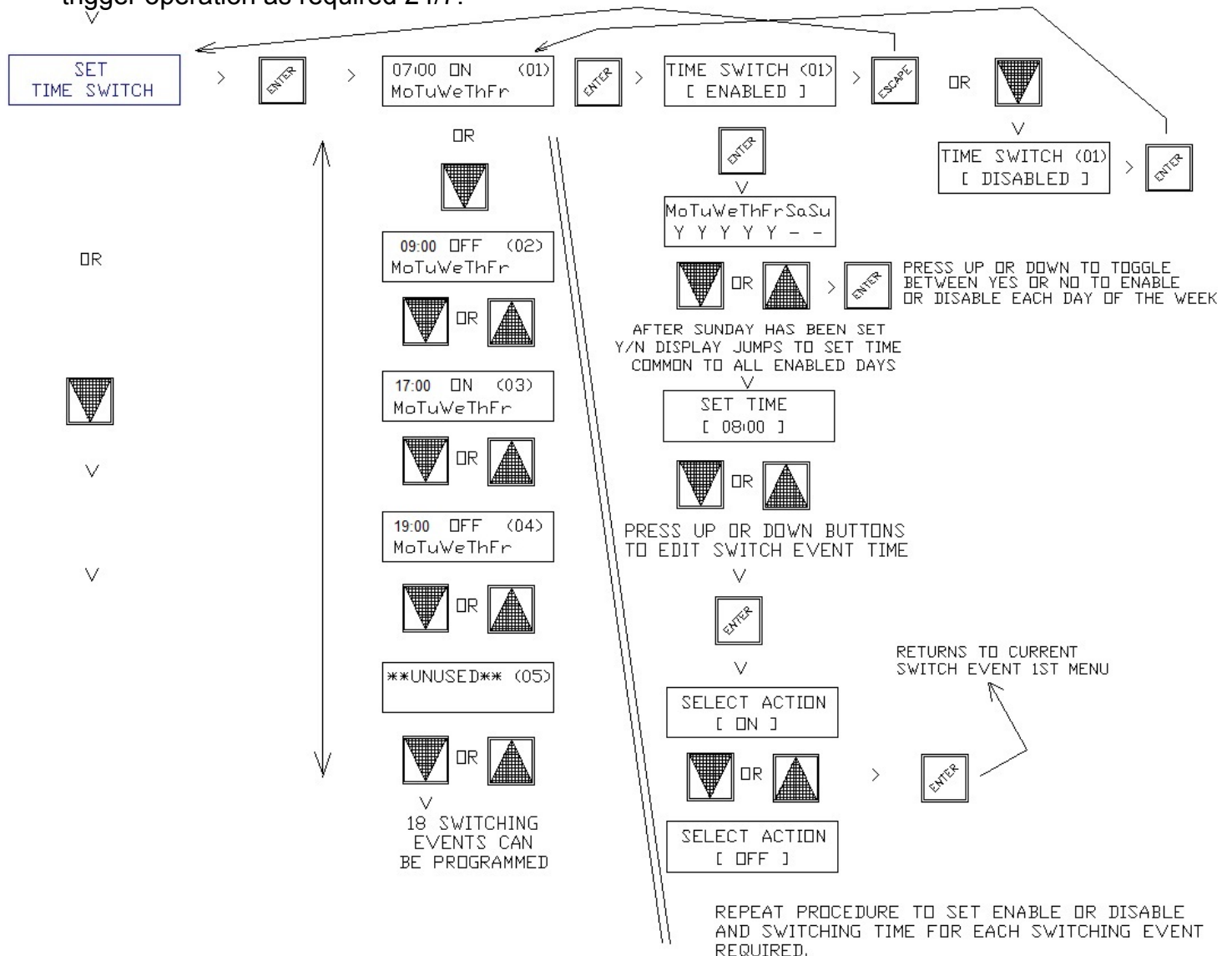

VIEW EVENT ON HISTORY

The controller now has a simple 20 event data logger that records input events that cause an output response to help diagnose alarm causes and system behavior. Note : After 20 events are recorded new events overwrite the oldest event.

To access the logger, press the fascia ENTER button to open the menu system, using the DOWN button, scroll down through the menu until "VIEW EVENT ON HISTORY" is displayed.

Press the ENTER button to open this menu & view the 1st (if any) ON event triggers.

The LCD display shows the event # starting at 01, followed by the event description and the sensor input number that caused the event. On the bottom line is recorded the time and date that the triggered the event.

DISPLAYED SCREEN INDICATING
A SENSOR FAULT HAS OCCURED

EVENT #	EVENT DESCRIPTION	SENSOR #
---------	-------------------	----------

01 :	CO FAULT	#4
23/05/2018		09:20

EVENT DATE & TIME

The 1st event is the newest, followed by older events up to a maximum of 20 events.

To erase the event history scroll up from the 1st event and the LCD screen will display a message asking to "ERASE WHOLE HISTORY" ?, Press ENTER to delete history or press the ESC button to exit event history leaving history intact. Other event screens are shown below.

DISPLAYED SCREEN WHEN
NO EVENTS HAVE BEEN
RECORDED

No event
history

DISPLAYED SCREEN INDICATING
SYSTEM STARTED BY IDLE RUN
TIMER



05 :	IDLE RUN TIMER	
23/05/2018		11:35



DISPLAYED SCREEN INDICATING
TIME SWITCH FORCED RUN IS
SWITCHED ON + THE D3 & M
LINK WAS MADE(connected)

02 :	T/Sw. + D3	
23/05/2018		09:00

CONFIGURE CONTROLLER (+ SUB MENU'S)

To alter controller configuration , scroll to the main menu called "**CONFIGURE CONTROLLER**" & press 

The controller will request a 4 digit password which is "9562" use  or  &  buttons to set.

Press  or  Buttons

to scroll through sub menus &

press  to edit

- SET NUMBER OF SENSORS > # of CO sensors , # of NO2 sensors
- SET OCCUPANCY TYPE > Unoccupied, Occupied, Custom (> **various sub menus**)
- EDIT OUTPUT DELAY TIMERS > Delay on & run on timer settings per relay
- SET AVERAGING TIME WINDOW > Sensor averaging time window TWA
- SET IDLE PERIOD FAN RUN TIMER > Time gap & run duration
- EDIT FORCED FAN D3/IDLE SPEED > Speed setting for forced fan run override
- Y2 APPLICATION > Select Y2 as fixed 10vdc or Y1 mirror
- CONFIGURE MODBUS > RS485 modbus comms settings
- RESTORE FACTORY DEFAULTS > Clear memory & return controller to defaults

-SET NUMBER OF SENSORS

Press  to open the "**SET NUMBER OF SENSORS**" sub menu.



NUMBER OF CO SENSORS menu opens displaying current setting.

In the "**NUMBER OF CO SENSORS**" menu Press  or  buttons to alter the quantity of connected CO sensors.

Press  to accept # of connected CO sensors & jump to number of NO2 sensors connected

In the "**NUMBER OF NO2 SENSORS**" menu Press  or  buttons to alter the quantity of connected sensors.





Press  button to accept the # of connected NO2 sensors and return to this main sub menu.

Press  or  button to Scroll through the other Configure Controller sub menus, & select using 

or press  to escape to the main running screen

-SET OCCUPANCY TYPE

To enter “**SET OCCUPANCY TYPE**” menu Press  or  or  to move to another menu.

In the “**OCCUPANCY TYPE**” screen Press  or  to scroll the choice of “**OCCUPIED**”, “**UNOCCUPIED**” or “**CUSTOM**” choosing “**OCCUPIED**” or “**UNOCCUPIED**” using the  button will load those settings and return you to this menu. choosing “**CUSTOM**” using the  will jump to its 1st sub menu “**EDIT CO LEVELS**”.

SUB MENU “**CUSTOM**” in Occupancy type

USE THIS SUB MENU TO EDIT ALL VALUES FOR CO & NO2 TRIGGER POINTS, TIME DELAYS AND RESPONSE TIMES & METHOD. **NOTE : USING THIS MENU SHIFTS RESPONSABILITY FROM HEVAC CONTROLS PTY.LTD TO THE USER FOR COMPLIANCE WITH AUSTRALIAN STANDARDS AS1668.2**



IF “**CUSTOM**” IS SELECTED AS THE OCCUPANCY TYPE, THE FOLLOWING SUB MENUS ARE ACCESSABLE

- EDIT CO OUTPUT ON/OFF VALUES** - set On, Off, Start & Range trigger points of relative output relays & Y1 in ppm CO
- EDIT NO2 OUTPUT ON/OFF VALUES** - set On, Off, Start & Range trigger points of relative output relays & Y1 in ppm NO2
- SET SENSOR O/P RESPONSE METHOD** - choose Time Weighted Average (**TWA**) or Current Value (**CV**) for each output

- EDIT CO OUTPUT ON/OFF VALUES

(CO LOW SPEED FAN SETTINGS - RELAY 2)

To enter “**EDIT CO OUTPUT ON/OFF VALUES**” menu Press  or  to jump to “**EDIT NO2 LEVELS**” menu.

Edit “**CO LOW SPEED FAN OFF**” using the  or  buttons to alter the low speed FAN turn OFF point in ppm CO.

Press  to accept & jump to edit screen “**LOW SPEED FAN ON**”



Edit “**CO LOW SPEED FAN ON**” using the  or  buttons to alter the low speed FAN turn ON point in ppm CO.

Press  to accept & jump to edit screen “**CO HIGH SPEED FAN OFF**”



(CO HIGH SPEED FAN SETTINGS - RELAY 1)

Press  to edit “**HIGH SPEED FAN OFF**” using the  or  buttons to alter high speed turn OFF point in ppm CO.



Press  to accept & jump to edit screen “**HIGH SPEED FAN ON**”

Edit “**HIGH SPEED FAN ON**” using the  or  buttons to alter the high speed FAN turn ON point in ppm CO.



(CO STROBE SETTINGS - RELAY 3)

Edit "STROBE OFF" using the  or  buttons to alter the STROBE turn off point in ppm CO.



Press  to accept & jump to edit screen "STROBE ON"

Edit "STROBE ON" using the  or  buttons to alter the STROBE turn ON point in ppm CO.



(CO SIREN SETTINGS - RELAY 4) **NOTE N/C CONTACT USED FOR FAIL SAFE ALARM**

Edit "SIREN OFF" using the  or  buttons to alter the SIREN turn off point in ppm CO.

Press  to accept & jump to edit screen "SIREN ON"

Edit "SIREN ON" using the  or  buttons to alter the SIREN turn ON point in ppm CO.

(CO VSD RAMP SETTINGS - Y1)

Edit "VSD RAMP START" using the  or  buttons to alter the VSD RAMP start point in ppm CO.

Press  to accept & jump to edit screen "VSD RAMP P BAND"

Edit "VSD RAMP P-BAND" using the  or  buttons to alter the VSD RAMP P BAND in ppm CO.



Press  to accept & jump to edit screen "VSD RAMP I-TIME"

Edit "VSD RAMP I-TIME" using the  or  buttons to alter the VSD RAMP Integral TIME in Minutes.

Press  to accept & jump to edit screen "VSD MIN O/P LEVEL"

Edit "VSD MIN O/P LEVEL" using the  or  buttons to alter the VSD Minimum Output level.



Press  to accept & return to this sub menu.

Press  to jump to "EDIT NO2 LEVELS" or press  to move back up through the menus.



-EDIT NO2 ON/OFF OUTPUT VALUES

(NO2 LOW SPEED FAN SETTINGS - RELAY 2)

To enter "EDIT NO2 ON/OFF VALUES" menu Press   to jump to "SET RESPONSE METHOD" menu. .

Edit "NO2 LOW SPEED FAN OFF" using the  or  buttons to alter the low speed fan turn off point in ppm NO2

Press  to accept & jump to edit screen "LOW SPEED FAN ON"

Edit "NO2 LOW SPEED FAN ON" using the  or  buttons to alter the low speed FAN turn ON point in ppm NO2.

Press  to accept & jump to edit screen "NO2 HIGH SPEED FAN OFF"

(NO2 HIGH SPEED FAN SETTINGS - RELAY 1)

Press  to edit "HIGH SPEED FAN OFF" using the  or  buttons to alter high speed turn OFF point in ppm NO2.

Press  to accept & jump to edit screen "HIGH SPEED FAN ON"

Edit "HIGH SPEED FAN ON" using the  or  buttons to alter the high speed FAN turn ON point in ppm NO2.

(NO2 STROBE SETTINGS - RELAY 3)

Edit "STROBE OFF" using the  or  buttons to alter the STROBE turn off point in ppm NO2.



Press  to accept & jump to edit screen "STROBE ON"

Edit "STROBE ON" using the  or  buttons to alter the STROBE turn ON point in ppm NO2.

(NO2 SIREN SETTINGS - RELAY 4)

Edit "SIREN OFF" using the  or  buttons to alter the SIREN turn off point in ppm NO2.

Press  to accept & jump to edit screen "SIREN ON"

Edit "SIREN ON" using the  or  buttons to alter the SIREN turn ON point in ppm NO2.



(NO2 VSD RAMP SETTINGS - Y1)

Edit "VSD RAMP START" using the  or  buttons to alter the VSD RAMP start point in ppm NO2.

Press  to accept & jump to edit screen "VSD RAMP P-BAND"

Edit "VSD RAMP P-BAND" using the  or  buttons to alter the VSD RAMP P-BAND in ppm NO2.

Press  to accept & jump to edit screen "VSD RAMP I-TIME"

Edit "VSD RAMP I-TIME" using the  or  buttons to alter the VSD RAMP Integral TIME in Minutes.



Press  to accept & jump to edit screen "VSD MIN O/P LEVEL"

Edit "VSD MIN O/P LEVEL" using the  or  buttons to alter the VSD Minimum Output level.



Press  to accept & jump to edit screen "SET RESPONSE METHOD"

-SET SENSOR O/P RESPONSE METHOD - (TWA or CV)



Use this menu to set whether an output relay (or the VSD ramp) should respond to the highest sensor signal but which is averaged out over a time window period using the TWA time setting, or to respond to the highest actual current sensor value (CV).

Edit "LOW SPEED ON/OFF CONTROL METHOD" using the  or  buttons to select "CV" or "TWA".



Press  to accept & jump to edit screen "HIGH SPEED CONTROL METHOD"

Edit "HIGH SPEED ON/OFF CONTROL METHOD" using the  or  buttons to select "CV" or "TWA".

Press  to accept & jump to edit screen "STROBE ON/OFF CONTROL METHOD"

Edit "STROBE ON/OFF CONTROL METHOD" using the  or  buttons to select "CV" or "TWA".

Press  to accept & jump to edit screen "SIREN ON/OFF CONTROL METHOD"

Edit "SIREN ON/OFF CONTROL METHOD" using the  or  buttons to select "CV" or "TWA".

Press  to accept & jump to edit screen "VSD RAMP CONTROL METHOD"

Edit "VSD RAMP CONTROL METHOD" using the  or  buttons to select "CV" or "TWA".

Press  to accept & return to this sub menu Set Response Method.



you are here in the menu tree



SUB MENUS UNDER "CONFIGURE CONTROLLER"

- SET NUMBER OF SENSORS
- SET OCCUPANCY TYPE > Unoccupied, Occupied, or (Custom > various sub menus)
- EDIT OUTPUT DELAY TIMERS
- SET AVERAGING TIME WINDOW TWA
- SET IDLE PERIOD FAN RUN TIMER
- SET D1 (fan) FAULT MODE STATE
- EDIT FORCED FAN D3/IDLE SPEED
- CONFIGURE MODBUS
- RESTORE FACTORY DEFAULTS

To jump to the another main sub menu from **this point** press  twice till "SET OCCUPANCY TYPE" is displayed

Then use the  or  buttons to move through the CONFIGURE sub menus.

or repeatedly Press  to move back up through the menus and to exit to the main running screen.

-EDIT OUTPUT DELAY TIMERS

USE THIS MENU TO ADJUST THE DELAY ON AND RUN ON TIME DELAYS FOR EACH RELAY OUTPUT (COMMON FOR CO & NO2 RESPONSE)

Edit "LOW SPEED FAN ON DELAY" using the  or  buttons to alter the ON time delay in mins & secs.

Press  to accept & jump to edit screen "LOW SPEED FAN RUN ON TIMER"

Edit "LOW SPEED FAN RUN-ON" using the  or  buttons to alter the run ON time delay in mins & secs.

Press  to accept & jump to edit screen "HIGH SPEED START DELAY"

Edit "HIGH SPD FAN ON DELAY" using the  or  buttons to alter the ON time delay in mins & secs.

Press  to accept & jump to edit screen "HIGH SPEED FAN RUN ON TIMER"



Edit "HIGH SPEED FAN RUN-ON" using the  or  buttons to alter the run ON time delay in mins & secs.

Press  to accept & jump to edit screen "STROBE ON DELAY"

Edit "STROBE ON DELAY" using the  or  buttons to alter the STROBE turn ON delay in mins & secs.

Edit "SIREN ON DELAY" using the  or  buttons to alter the SIREN turn ON delay in mins & secs.



Press  to accept & and return to this main sub menu.

Press the  or  buttons to scroll to other main sub menus or press  to exit programming



-SET TIME AVERAGING WINDOW

USE THIS MENU TO CHANGE THE TIME WINDOW THAT A SENSOR MEASUREMENT IS AVERAGED OVER , AS1668.2 ACCEPTS THIS SET TO 8 HOURS, ALTHOUGH THIS SETTING WILL CAUSE VERY DELAYED SENSOR RESPONSE. SETTING THIS VALUE LOWER EXCEEDS REQUIREMENTS AND WILL GIVE FASTER SENSOR RESPONSE, OR USING THE "CUSTOM MENU" OUTPUTS CAN BE ALTERNATIVELY INDIVIDUALLY SET TO USE "CURRENT VALVE" WHICH THEN USES THE HIGHEST REAL TIME ACTUAL SENSOR VALUE.

Press  to allow editing of the existing value

Press the  or  buttons to change the time window in hours & minutes .

Press  to accept the new value & return to this main sub menu.

Press the  or  buttons to scroll to other main sub menus or press  to exit programming

-SET IDLE PERIOD FAN RUN TIMER

USE THIS MENU TO SET THE IDLE PERIOD AFTER WHICH THE FAN WILL AUTOMATICALLY START AND THE AMOUNT OF TIME THE FAN THEN RUNS FOR TO PROVIDE MINIMUM VENTILATION AIR TURNOVER REQUIREMENTS

Press to edit settings in the menu "SET IDLE PERIOD FAN RUN TIMER"

Edit "IDLE PERIOD RUN DELAY" using the or buttons to set the time gap that triggers the fan in an idle period.

Press to accept & jump to edit screen "RUN FOR TIME" screen.

Edit "RUN FOR TIME" using the or buttons to set the length of time that the fan then runs for in minutes.

Press to accept & jump to edit screen "INHIBIT IDLE RUN FROM" screen.

Edit "INHIBIT IDLE RUN FROM" using the or buttons to set start lockout time, to inhibit idle fan run start.

Press to accept & jump to edit screen "INHIBIT IDLE RUN UNTIL" screen.

Edit "INHIBIT IDLE RUN UNTIL" using the or buttons to set finish lockout time, to allow idle fan run start.

Press to accept and return to this sub menu

Press the or buttons to scroll to other main sub menus or press to exit programming

-SET D1 (fan) FAULT MODE STATE

USE THIS MENU TO SET CONTROLLERS RESPONSE TO A FAN FAULT CAUSED BY AN OPENING OR CLOSING CONTACT ON D1 & M

Press to edit settings in the menu "SET D1 FAULT MODE STATE"

Display shows existing state (factory default is close on fault)

Edit "D1 FAULT MODE STATE" using the or buttons to select [CLOSE] or [OPEN] on fault

Answer the next screen question as to whether you require the D1 fan fault input to be only read when the fan enable relay (R2) is enabled (this suits the use of N/C fan fault inputs so as not to cause faults during system idle. (factory default is NO.)

INTERLOCK W(ith). R2 FAN CALL ? press or to select [NO] or [YES]

Press to accept and return to this sub menu

Press the or buttons to scroll to other main sub menus or press to exit programming

-EDIT FORCED FAN D3/IDLE SPEED

USE THIS MENU TO SET THE FAN SPEED USED DURING FORCED **ON** OPERATION DUE TO THE INTERNAL TIME SWITCH/D3 OR IDLE TIMER OPERATION.

Press to edit settings in the menu "EDIT FORCED FAN D3/IDLE SPEED "

Press to accept and return to this main menu

Press the or buttons to scroll to other main sub menus or press to exit programming

Edit "FORCED RUN FAN SPEED" using the or buttons to set VSD speed during forced run operation

if the 2 speed ON/OFF CONTROL (no VSD) link is fitted, then instead of VSD speed , LOW or HIGH speed is selectable

Press to accept and return to this main menu

Press the or buttons to scroll to other main sub menus or press to exit programming

- Y2 APPLICATION

Output terminal Y2 ex factory is preset as a 10vdc source , but can alternatively be set to mirror the output of Y1 to allow the controller to drive upto ~ 6 vsd's (3 per output). Select and open this menu to set the required use of this output using the or buttons to select then press to set, then press to exit this menu.

-CONFIGURE MODBUS

TO ENABLE THE USE OF MODBUS SET THE SETTINGS IN THE MENU BELOW AS REQUIRED TO MATCH THE SYSTEM CONNECTED, ALSO NOTE : INTERNAL RED CONNECTOR LINKS ON THE BOTTOM CIRCUIT BOARD HAVE TO BE RELOCATED TO TRANSFER USE OF TERMINALS "X5, X6 & X7" FROM SENSOR INPUT USE TO MODBUS USE. WITH POWER OFF, OPEN THE HOUSING & LOCATE THE 3 RED JUMPERS ON THE PCB LABELED "CN3 & CN4" (3 JUMPERS) REPOSTION THESE 3 JUMPERS FROM THE TOP 2 PINS (V) TO THE BOTTOM 2 PINS (C).

Press **ENTER** to edit settings in the menu "CONFIG MODBUS"

Edit "MODBUS Address" using the **▲** or **▼** buttons.

Press **ENTER** to accept address and jump to edit screen for the baudrate "MODBUS BAUDRATE"

Edit "MODBUS Baudrate" address using the **▲** or **▼** buttons.

Press **ENTER** to accept and return to this main menu.

Press the **▲** or **▼** buttons to scroll to other main sub menus or press **ESC** to exit programming

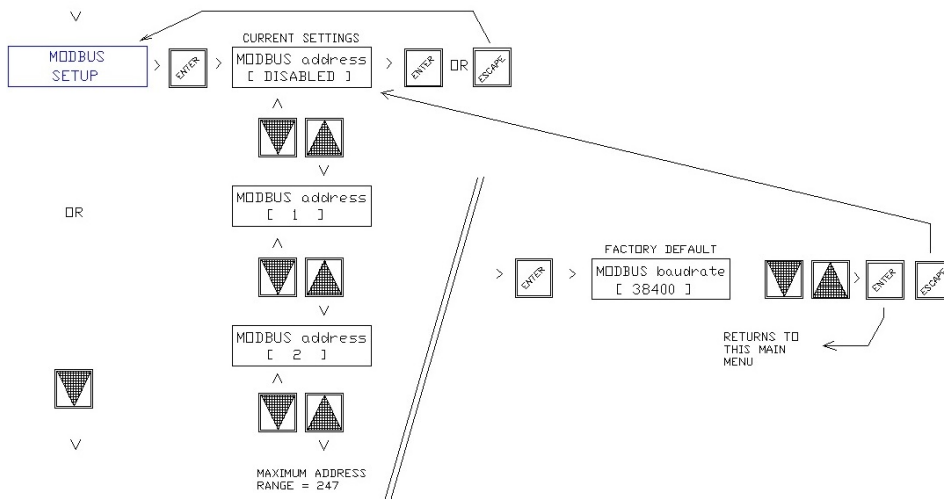

MODBUS MEMORY MAP

Modic on	Addr ess	Access	Description	Units	Type	Explanation	input	Defau	Min	Max	Error	InternalUs e	Internal Use
Read Coils												Up Address	Byte Address
00161	160	ReadOnly	Relay 0	-	boolean	-	-	-	-	-	-	00160	20.0
01001	1000	ReadOnly	Relay 1	-	boolean	TRUE if relay is active	-	-	-	-	-	00000	n/a
01002	1001	ReadOnly	Relay 2	-	boolean	TRUE if relay is active	-	-	-	-	-	00001	n/a
01003	1002	ReadOnly	Relay 3	-	boolean	TRUE if relay is active	-	-	-	-	-	00002	n/a
01004	1003	ReadOnly	Relay 4	-	boolean	TRUE if relay is active	-	-	-	-	-	00003	n/a
01005	1004	ReadOnly	Relay 5	-	boolean	TRUE if relay is active	-	-	-	-	-	00004	n/a
Inputs													
10001	0	ReadOnly	D1-FAN FLT	input 0	boolean	TRUE if input is active	-	-	-	-	-		
10002	1	ReadOnly	D2-MUTE	input 1	boolean	TRUE if input is active	-	-	-	-	-		
10003	2	ReadOnly	D3-MAN.RUN	input 2	boolean	TRUE if input is active	-	-	-	-	-		
10004	3	ReadOnly	D4-LO/HI FAN (not VSD)	input 3	boolean	TRUE if input is active	-	-	-	-	-		
Write Coils												Semaphore Address	Byte Address
00169	168	Read/Write		-	boolean		-	-	-	-	-	00168	210
Read Registers													Byte Address
45001	5000	ReadOnly	Controller model	-	unsigned 16bit	Controller model number		1	-	-	-		
45002	5001	ReadOnly	MODBUS mapping version	-	unsigned 16bit	MODBUS memory/coil mapping version number		1	-	-	-		
41023	1022	ReadOnly	Number of CO sensors	-	unsigned 8bit	Number of configured CO sensors (these will be the first group of sensors)		-	0	42	-		22
41024	1023	ReadOnly	Number of NO2 sensors	-	unsigned 8bit	Number of configured NO2 sensors (these appear after the CO sensors)		-	0	42	-		23
41025	1024	ReadOnly	Max CO sensor gas reading	ppm	unsigned 8bit	Maximum ppm level reported by all CO sensors		-	0	255	-		24
41026	1025	ReadOnly	Max NO2 sensor gas reading	ppm * 10	unsigned 8bit	Maximum ppm level reported by all NO2 sensors		-	0	25.5	-		25
41027	1026	ReadOnly	TwA CO gas reading	ppm	unsigned 8bit	Time weighted average of the maximum of all CO sensors		-	0	255	-		26
41028	1027	ReadOnly	TwA NO2 gas reading	ppm * 10	unsigned 8bit	Time weighted average of the maximum of all NO2 sensors		-	0	25.5	-		27
41029	1028	ReadOnly	Sensor 1 gas reading	ppm or ppm*10	unsigned 8bit	For CO sensor value is ppm, for NO2 sensor value is ppm * 10		-	0	250	255		28
41030	1029	ReadOnly	Sensor 2 gas reading	ppm or ppm*10	unsigned 8bit	For CO sensor value is ppm, for NO2 sensor value is ppm * 10		-	0	250	255		29
41031	1030	ReadOnly	Sensor 3 gas reading	ppm or ppm*10	unsigned 8bit	For CO sensor value is ppm, for NO2 sensor value is ppm * 10		-	0	250	255		30
41032	1031	ReadOnly	Sensor 4 gas reading	ppm or ppm*10	unsigned 8bit	For CO sensor value is ppm, for NO2 sensor value is ppm * 10		-	0	250	255		31
...							
41068	1067	ReadOnly	Sensor 40 gas reading	ppm or ppm*10	unsigned 8bit	For CO sensor value is ppm, for NO2 sensor value is ppm * 10		-	0	250	255		67
41069	1068	ReadOnly	Sensor 41 gas reading	ppm or ppm*10	unsigned 8bit	For CO sensor value is ppm, for NO2 sensor value is ppm * 10		-	0	250	255		68
41070	1069	ReadOnly	Sensor 42 gas reading	ppm or ppm*10	unsigned 8bit	For CO sensor value is ppm, for NO2 sensor value is ppm * 10		-	0	250	255		69
Write Registers													Byte Address
41023	1022	Read/Write		-	unsigned 16bit			0	-	-	-		22

-RESTORE FACTORY DEFAULTS

Press **ENTER** to access the choice of restoring settings to original factory defaults (unoccupied mode as per AS1668.2)

To restore factory defaults select [YES] using the **▲** or **▼** buttons, then press **ENTER**

Press **ESC** to exit programming & return to normal operation & running display

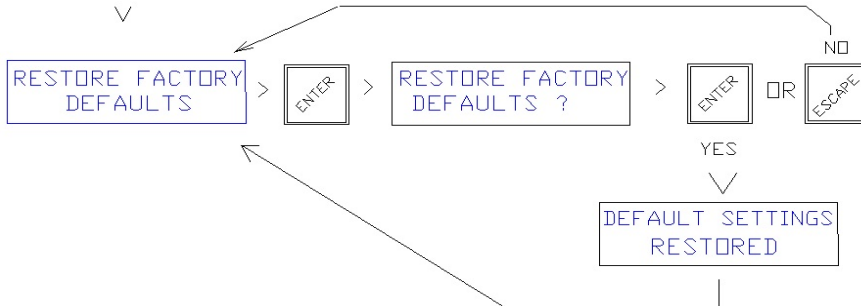

PLEASE NOTE : RESETTING THE CONTROLLER TO FACTORY DEFAULTS SETS THE CONTROLLER TO FULLY CONFORM TO UN-OCCUPIED AS1668.2 MODE SETTINGS USING 8HR TWA FOR ALL OUTPUTS . EX HEVAC SETTINGS ARE SET BEFORE DESPATCH SUCH THAT RELAYS 1 & 3 TO USE CURRENT VALUE AND THE TWA IS ALSO CHANGED TO 1 HR (FROM 8).

MENU SYSTEM CONCEPT & BASIC OVERVIEW

OPERATING DISPLAY

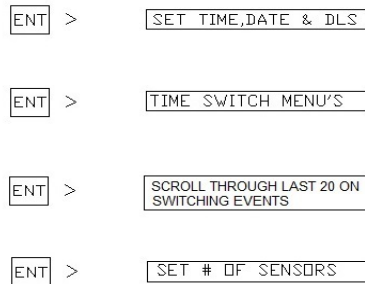
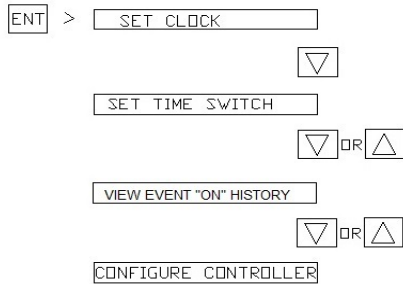

NOTE :
PRESSING THE **ESC** BUTTONS MOVES YOU BACK ONE SCREEN OR RETURNS TO THE ABOVE MENU

(PASSWORD = 9562)

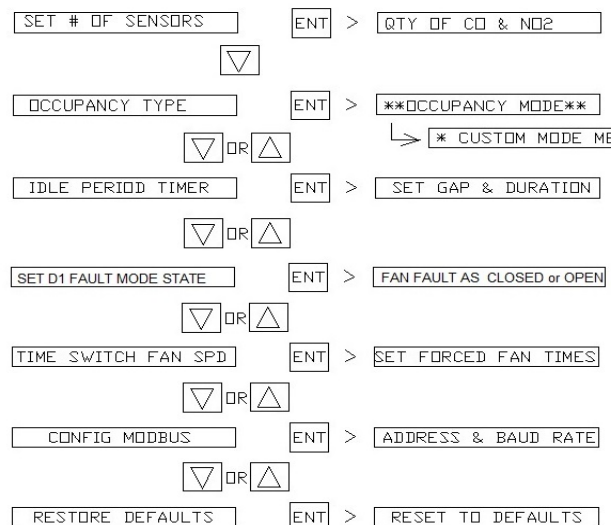
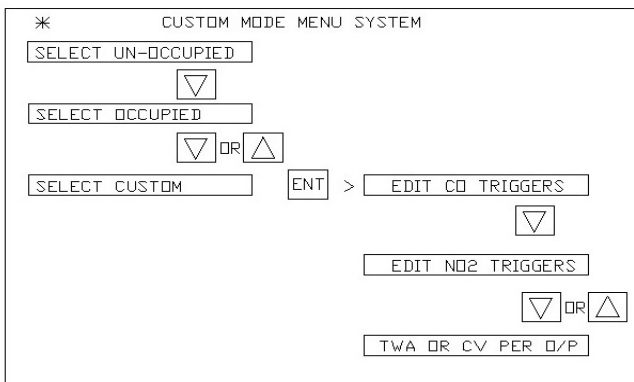

Application Example (1) 4 HEVAC HGS-CO SENSORS CONNECTED using 2 SPEED LO-HI FAN CONTROL

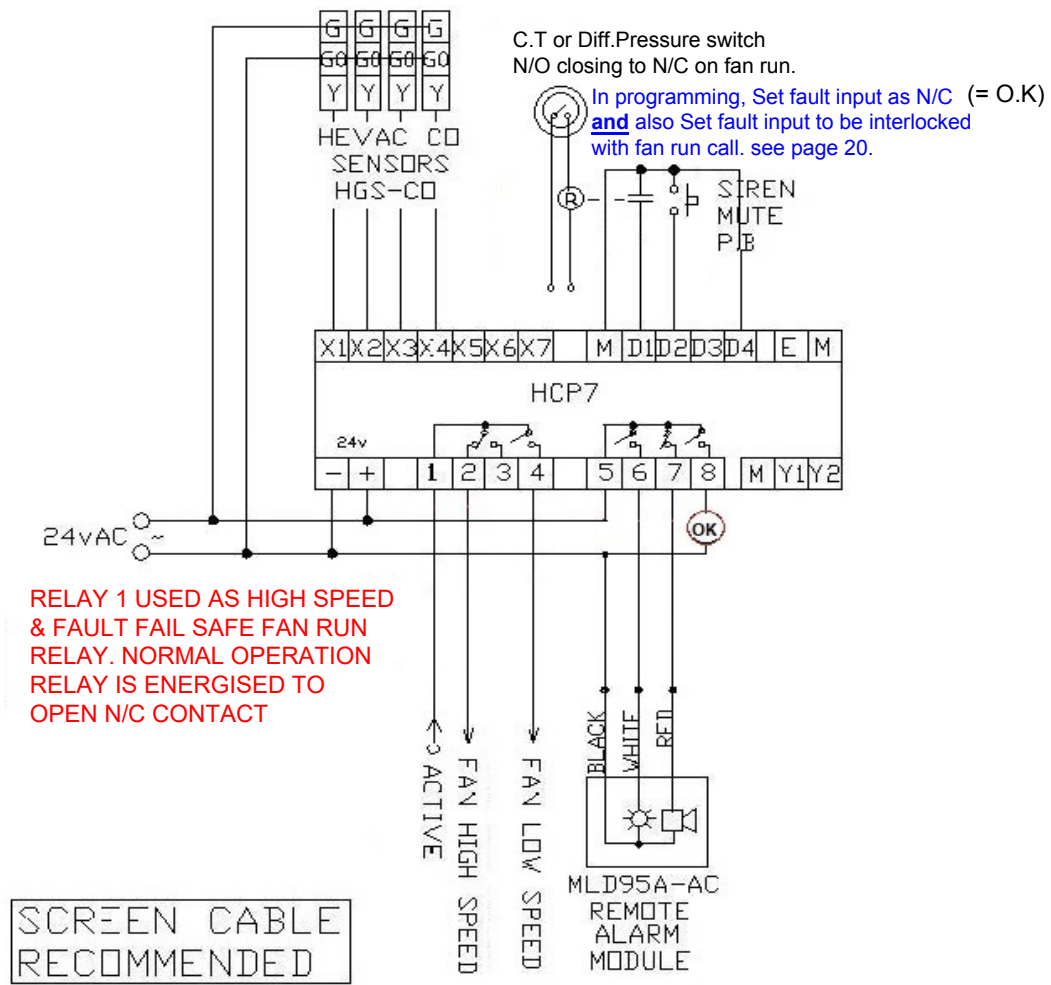

Application Example (2) 4 X HEVAC CO SENSORS & 2 X HEVAC NO2 SENSORS c/w MODULATING VSD OUTPUT

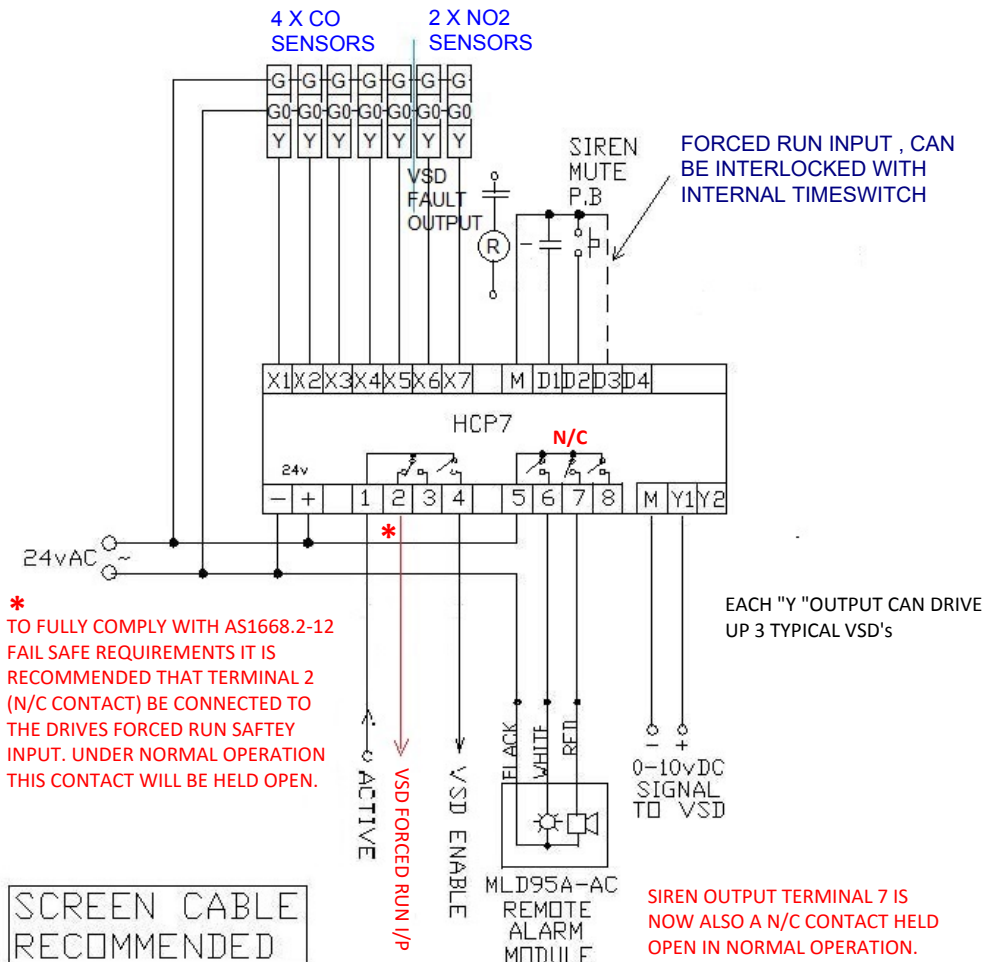

Application Example (3) 14 HEVAC CO SENSORS , c/w MODULATING VSD OUTPUT

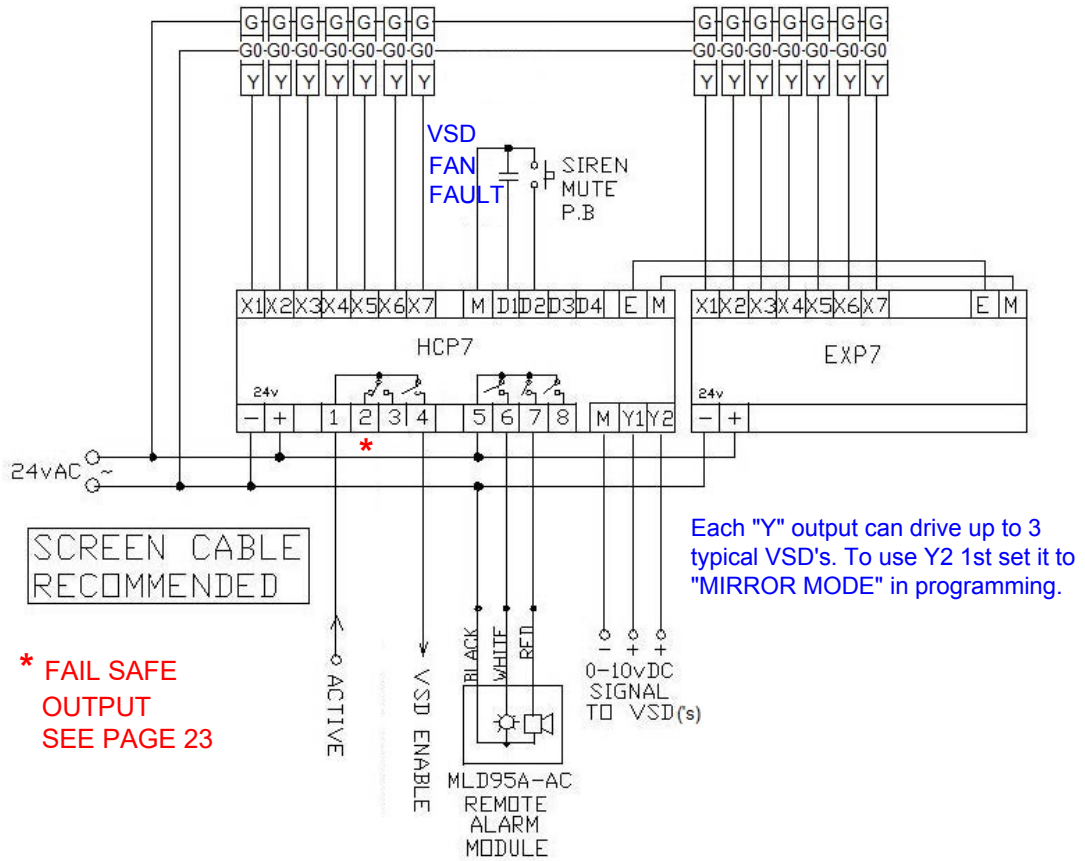

Application Example (4) 12 HEVAC CO sensors , c/w on/off thermostats for temperature control

