



OpenAir™

## Air damper actuators

Rotary version, AC/DC 24 V and AC 230 V

**GSD...1**  
**GQD...1**

GSD...1

- Electric motor driven actuators for open-close control (1-wire, SPST)
- 2 Nm nominal torque
- AC/DC 24 V or AC 230 V rated voltage
- Pre-wired with 0.9 m cable

GQD...1

- Electric motor driven actuators for 2-position, 3-position and DC 0...10 V control
- 2 Nm nominal torque
- Spring return
- AC/DC 24 V or AC 230 V rated voltage
- Pre-wired with 0.9 m cable

## Use

- For damper areas up to 0.3 m<sup>2</sup>, friction dependent.
- For directly driven zone dampers used to control air flow in ducts.

## Type Summary

**Non-spring return -**  
rotary air damper  
actuators

Type	Operating voltage	Control signal	Cable length	Coupling
GSD121.1A	AC/DC 24 V	Open-close *	0.9 m	8...15 mm
GSD321.1A	AC 230 V	Open-close *	0.9 m	8...15 mm

\* 1-wire, SPST: single pole - single-throw

**Spring return -**  
rotary air damper  
actuators



Type	Operating voltage	Control signal	Cable length	Coupling
GQD121.1A	AC/DC 24 V	2-position	0.9 m	8...15 mm
GQD321.1A	AC 230 V	2-position	0.9 m	8...15 mm
GQD131.1A	AC 24 V / DC 24...48 V	3-position	0.9 m	8...15 mm
GQD161.1A	AC 24 V / DC 24...48 V	DC 0...10 V	0.9 m	8...15 mm



## Functions

Type	GSD121.1A GSD321.1A	GQD121.1A GQD321.1A	GQD131.1A	GQD161.1A
Control type	Open-close *	2-position	3-position	DC 0...10 V
Rotary direction	Clockwise or counter-clockwise movement depends on the mounting position of the actuator on the damper shaft... ...and on the type of control.			
Spring return	On power failure or when the operating voltage is switched off, the spring returns the actuator to its mechanical zero.			

## Technical Data

⚠ Power supply AC/DC 24 V	Operating voltage AC / Frequency	AC 24 V ± 20 % ; 50 / 60 Hz
	Operating voltage DC	DC 24 V ± 15 %
	Power consumption	
	– GSD121.1A: (running) (holding)	2 VA / 1.5 W 1 VA / 0.5 W
⚠ Power supply AC 24 V DC 24...48 V	Operating voltage AC / Frequency	AC 24 V ± 20 % ; 50 / 60 Hz
	Operating voltage DC	DC 24...48 V ± 20 %
	Power consumption	
	– GQD131.1A: (running) (holding)	4 VA / 2.5 W 3 VA / 1.5 W
	– GQD161.1A: (running) (holding)	4.5 VA / 3 W 3.5 VA / 2 W
Safety extra-low (SELV) or Protection by extra-low voltage (PELV) as per HD 384		
Requirements of external safety isolating transformer (100 % duty cycle) EN 61 558		
Fuse for incoming supply line (fast) 2 A		

 Power supply AC 230 V	Operating voltage / Frequency	AC 230 V $\pm$ 15 %; 50 / 60 Hz
	Fuse for incoming supply line (fast)	2 A
	Power consumption	
	– GSD321.1A: (running)	12 VA / 2 W
	(holding)	12 VA / 2 W
– GQD321.1A: (running)	10 VA / 4.5 W	
(holding)	7 VA / 3 W	
Function data	Nominal torque	2 Nm
	Maximum torque	6 Nm
	Nominal rotational angle	90°
	Maximum rotational angle (mechanically limited)	95° $\pm$ 2°
	Runtime for nominal rotational angle 90 °	30 s
	Closing time with spring return (on power failure)	15 s
	Duty cycle	100 %
	Direction of rotation	Clockwise / Counter-clockwise
	Mechanical life	
	– GSD...1	25 000 cycles
	– GQD...1	60 000 cycles
Positioning signal for GQD131.1A	Contact voltage	AC 24 V / DC 24...48 V or AC 0 V
	Contact current	typically 8 mA
Positioning signal for GQD161.1A	Input voltage Y(max)	DC 0...35 V
	Operating range Y	DC 0...10 V
Connection cables	Cable length	0.9 m
	Cross-section	0.75 mm <sup>2</sup>
Housing protection	Degree of protection as per EN 60 529	IP40
Protection class	Insulation class	EN 60 730
	– AC 230 V	
	– AC/DC 24 V	
Environmental conditions	Operation	IEC 721-3-3
	– Climatic conditions	Class 3K5
	– Mounting location	interior, weather-protected
	– Temperature extended	-32...+55 °C
	– Humidity (non-condensing)	< RH 95 %
	Transport	IEC 721-3-2
	– Climatic conditions	Class 2K3
	– Temperature extended	-32...+70 °C
	– Humidity (non-condensing)	< 95 % R.H.
	Storage	IEC 721-3-1
	– Climatic conditions	Class 1K3
	– Temperature extended	-32...+50 °C
	– Humidity (non-condensing)	< 95 % R.H.
Mechanical conditions	Class 2M2	



Standards	Product Safety	
	Automatic electrical controls for household and similar use (type 1)	IEC/EN 60 730-2-14
	Electromagnetic compatibility	
	– Immunity	IEC/EN 61 000-6-2
	– Emissions	IEC/EN 61 000-6-3
	 C-Tick conformity to	
	– Australian EMC Framework	Radio Communication Act 1992
	– Radio Interference Emission Standard	AS / NZS 3548
	 CE conformity to	
	– EMC directive	2004/108/EEC
– Low voltage directive	2006/95/EEC	
Dimensions	Actuator	
	W × H × D (see section “Dimension”)	70 X 121.4 X 62.5
	Damper shaft	
	– Rectangular	6...11 mm
	Min length	20 mm
	Max shaft hardness	300 HV
	– Round	8...15 mm
	Min. length	20 mm
	Max. shaft hardness	300 HV
	Weight	Without packaging
– GSD..21.1A		0.44 kg
– GQD121.1A		0.48 kg
– GQD321.1A		0.49 kg
– GQD131.1A		0.50 kg
– GQD161.1A		0.50 kg

## Mechanical design

### Basic components

Housing	Fiberglass reinforced plastic
Gear train	Maintenance-free, low-noise

### Engineering notes

<b>STOP</b>	This section explains general and system-specific regulations for mains and operating voltages. It also contains important information regarding your own safety and that for your plant.
Intended use	Use these actuators as described in the basic system documentation for the applied control systems. Additionally, take account of all actuator-specific features and conditions as described in the brief description on the front page of this data sheet (bold print) and in the sections “Use”, “Engineering Notes” and “Technical Data”.
	The sections flagged with the warning symbol illustrated in the left margin contain safety-related requirements and restrictions. It is important that these are adhered in order to prevent physical injury and equipment damage.
 AC/DC 24 V supply	Operate the actuators only on safety extra-low voltage (SELV) or protective extra-low voltage (PELV) as per HD 384.
 AC 230 V supply	The actuators are double-insulated and there is no connection for the protective ground.

## CAUTION

### Do not open the actuator!

- The actuators are maintenance-free.
- Any repair work must be conducted by the manufacturer only.
- Opening the actuator will void the warranty.
- Spring return actuators contain pre-tensioned springs. Only trained personnel may open such actuators (by means of special tools).

Parallel connection

Up to 10 actuators of the same type can be electrically wired in parallel. The admissible cable length and cable cross-section must be observed.

Required actuator type

Selection of the actuator depends on several torque factors. After obtaining the damper torque rating (Nm/m<sup>2</sup>) from the manufacturer and determining the damper area, calculate the total torque required to move the damper as follows:

Non-spring return damper actuators

IF total torque (SF <sup>1</sup> )	Use type
≤ 2 Nm	GSD...1 (2 Nm) GXD...1 (1.5 Nm)
≤ 5 Nm	GDB...1 (5 Nm)
≤ 10 Nm	GLB...1 (10 Nm)
≤ 15 Nm	GEB...1 (15 Nm)
≤ 25 Nm	GBB...1 (25 Nm)
≤ 35 Nm	GIB... 1 (35 Nm)

Spring return damper actuators

IF total torque (SF <sup>1</sup> )	Use type
≤ 2 Nm	GQD...1 (2 Nm)
≤ 7 Nm	GMA...1 (7 Nm)
≤ 18 Nm	GCA...1 (18 Nm)

<sup>1</sup> Safety factor SF: When calculating the required torque, non-definable variables such as slight misalignment, damper age, etc. must be included as a safety factor. We recommend a safety factor of 0.8 (or 80 % of the torque characteristic)

Sizing transformers for AC 24 V

Use safety insulating transformers as per EN 61 558 with double insulation, designed for 100 % duty to supply SELV or PELV circuits.

Observe all local safety rules and regulations pertaining to the sizing and protection of transformers.

Determine the transformer power consumption by adding up the power consumption in VA for all actuators used.

Wiring and commissioning

Refer to the sections "Commissioning Notes" and "Wiring Diagrams" in this data sheet as well as to the HVAC job drawings.

## Mounting notes

Mounting instructions

All information and steps to properly prepare and mount the actuator are listed in the mounting instructions supplied with the actuator.

Mounting position

Mount the actuator in a position which ensures easy access to the cables and to the shaft adapter. Refer to the "Dimensions" section.

Damper shafts

Information on minimum length and diameter for the damper shaft is available in the "Technical Data" section.

## Commissioning notes

---

References	For commissioning, the following reference documentation must be available: <ul style="list-style-type: none"><li>• This data sheet</li><li>• Job diagram</li></ul>
Ambient conditions	Check to ensure that all permissible values, as contained in the section “Technical Data”, have been observed.
Mechanical check	<ul style="list-style-type: none"><li>• Check for proper mounting and ensure that all mechanical settings correspond to the plant-specific requirements. Additionally, ensure that the dampers are tightly closed when in the closed position.</li><li>• Check the direction of rotation.</li><li>• Fasten the actuator securely to avoid twisting and blocking of the actuator.</li></ul>
Electrical check	<ul style="list-style-type: none"><li>• Check to ensure that the cables are connected in accordance with the plant wiring diagram (see “Wiring Diagrams”).</li><li>• The operating voltage AC/DC 24 V (SELV/PELV) or AC 230 V must be within the tolerance values.</li></ul>

### Functional check

GSD121.1A	Power supply AC/DC 24 V wires red (1) and black (2) Control signal AC/DC 0 V <ul style="list-style-type: none"><li>• Wire orange (7) ON: actuator turns counter-clockwise</li><li>• Wire orange (7) OFF: actuator turns clockwise</li></ul>
GSD321.1A	Power supply AC 230 V wires brown (3) and blue (4) Control signal AC 230 V <ul style="list-style-type: none"><li>• Wire white (7) ON: actuator turns counter-clockwise</li><li>• Wire white (7) OFF: actuator turns clockwise</li></ul>
GQD121.1A	Power supply AC/DC 24 V wires red (1) and black (2) <ul style="list-style-type: none"><li>• Power ON: actuator turns clockwise</li><li>• Power OFF: actuator turns mechanically counter-clockwise (by spring)</li></ul>
GQD321.1A	Power supply AC 230 V wires brown (3) and blue (4) <ul style="list-style-type: none"><li>• Power ON: actuator turns clockwise</li><li>• Power OFF: actuator turns mechanically counter-clockwise (by spring)</li></ul>
GQD131.1A	Power supply AC 24 V / DC 24...48 V wires red (1) and black (2) Control signal AC 24 V / DC 24...48 V or AC 0 V <ul style="list-style-type: none"><li>• Wire violet (6) ON: Actuator turns clockwise</li><li>• Wire orange (7) ON: Actuator turns counter-clockwise</li><li>• Wire violet (6) and wire orange (7) ON: Actuator turns counter-clockwise</li><li>• Wire violet (6) and wire orange (7) OFF: Actuator stops</li><li>Power OFF: Actuator turns counter-clockwise (mechanical spring)</li></ul>
GQD161.1A	Power supply AC 24 V / DC 24...48 V wires red (1) and black (2) Control signal DC 10 V <ul style="list-style-type: none"><li>• Wire grey (8) ON: actuator turns clockwise</li><li>• Wire grey (8) OFF: actuator turns electrically counter-clockwise</li><li>Power OFF: actuator turns counter-clockwise (mechanical spring)</li></ul>

## Wiring diagrams

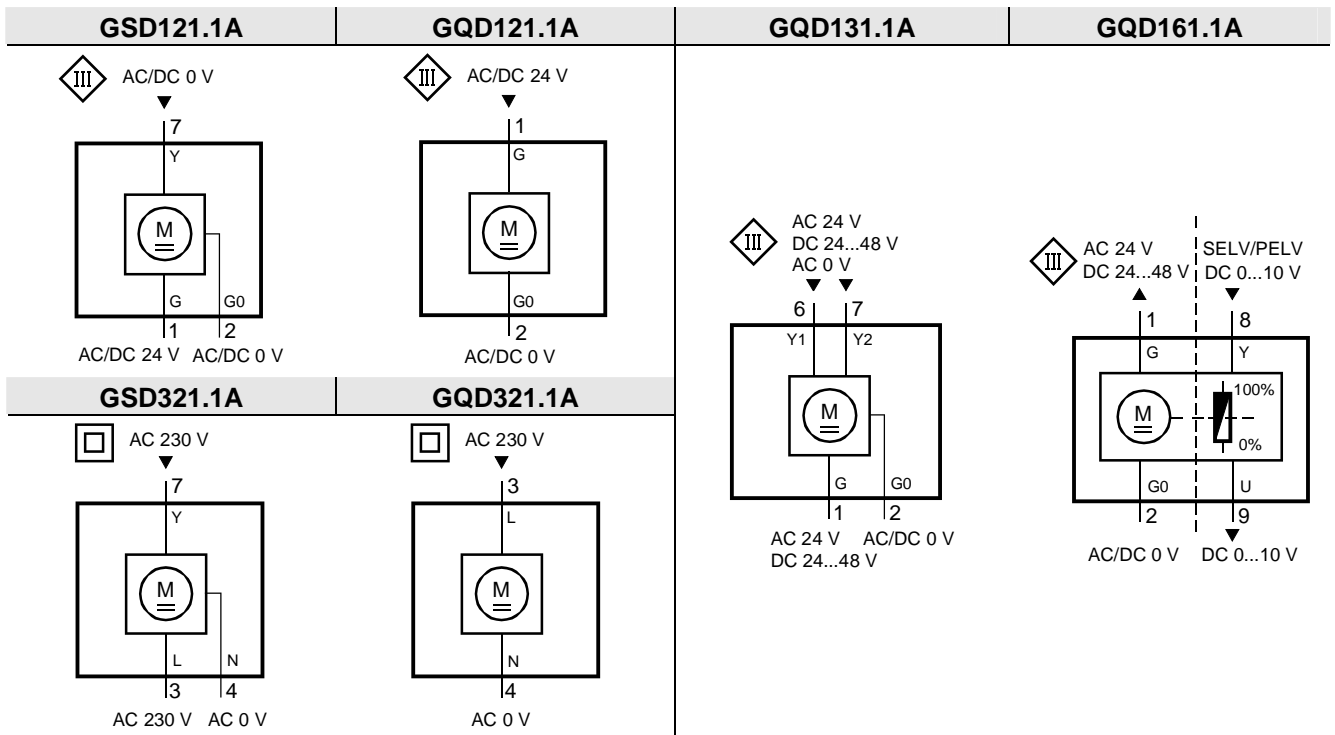

## Cable labeling

Pin	Cable				Meaning
	Code	No.	Color	Abbreviation	
<b>GSD121.1A</b> AC/DC 24 V	G	1	red	RD	System potential AC/DC 24 V
	G0	2	black	BK	System neutral
	Y	7	orange	OG	Pos. signal counter-clockwise AC/DC 0 V
<b>GSD321.1A</b> AC 230 V	L	3	brown	BN	Line AC 230 V
	N	4	blue	BU	Neutral
	Y	7	white	WH	Positioning signal counter-clockwise AC 230 V
<b>GQD121.1A</b> AC/DC 24 V	G	1	red	RD	System potential AC/DC 24 V
	G0	2	black	BK	System neutral
<b>GQD321.1A</b> AC 230 V	L	3	brown	BN	Line AC 230 V
	N	4	blue	BU	Neutral
<b>GQD131.1A</b> AC 24 V DC 24...48 V	G	1	red	RD	System potential AC 24 V / DC 24...48 V
	G0	2	black	BK	System neutral
	Y1	6	violet	VT	Pos. signal clockwise AC 24 V / DC 24...48 V or AC 0 V
	Y2	7	orange	OG	Pos. signal counter-clockwise AC 24 V / DC 24...48 V or AC 0 V
<b>GQD161.1A</b> AC 24 V DC 24...48 V	G	1	red	RD	System potential AC 24 V / DC 24...48 V
	G0	2	black	BK	System neutral
	Y	8	grey	GY	Positioning signal DC 0...10 V
	U	9	pink	PK	Position indication DC 0...10 V

# Dimensions

