



1857P01

Room Sensors

QFA20...

for relative humidity and temperature

- Operating voltage AC 24 V or DC 13.5...35 V
- Signal output DC 0...10 V for relative humidity
- Signal output DC 0...10 V or LG-Ni 1000 or T1 for temperature
- Accuracy of ± 3 % r.h. within comfort range
- Range of use $-15...+50$ °C / 0...95 % r. h. (non-condensing)

Use

In ventilating and air conditioning plants to acquire

- relative humidity and
 - temperature
- in rooms.

The QFA20... is used as a

- control sensor and
- measuring sensor for building automation and control systems or indicating units.

Type summary

Type reference	Temperature measuring range	Temperature signal output	Humidity measuring range	Humidity signal output	Operating voltage
QFA2000	None	None	0...100 %	Active, DC 0...10 V	AC 24 V or DC 13.5...35 V
QFA2020	0...50 °C	Passive, LG-Ni 1000	0...100 %	Active, DC 0...10 V	AC 24 V or DC 13.5...35 V
QFA2040	0...50 °C	Passive, T1	0...100 %	Active, DC 0...10 V	AC 24 V or DC 13.5...35 V
QFA2060	0...50 °C / $-35...+35$ °C	Active, DC 0...10 V	0...100 %	Active, DC 0...10 V	AC 24 V or DC 13.5...35 V

Ordering

When ordering, please give name and type reference.

Equipment combinations

All systems or devices capable of acquiring and handling the sensor's DC 0...10 V, LG-Ni 1000 or T1 output signal.

When using the passive sensors for averaging, we recommend to use the SEZ220 signal converter (refer to Data Sheet N5146).

Mode of operation

Relative humidity

The sensor acquires the relative humidity in the room via its capacitive humidity sensing element whose electrical capacitance changes as a function of the relative humidity. The electronic measuring circuit converts the sensor's signal to a continuous DC 0...10 V signal, which corresponds to 0...100 % relative humidity.

Temperature

The sensor acquires the temperature in the room via its sensing element whose electrical resistance changes as a function of the temperature.

Depending on the type of sensor, this change in resistance is converted either to an active DC 0...10 V output signal (\cong 0... 50 °C or -35...+35 °C) or is provided as a simulated passive LG-Ni 1000 or T1 output signal.

Simulated passive output signal

The measuring current from systems/devices for acquiring the electrical resistance of the passive sensor differs greatly and impacts self-heating of the temperature sensing element at the end of the measuring probe. To compensate the impact, the passive output signal is simulated with an electronic circuit.

Sensing elements, simulated

Characteristic LG-Ni 1000

Characteristic T1 (PTC)

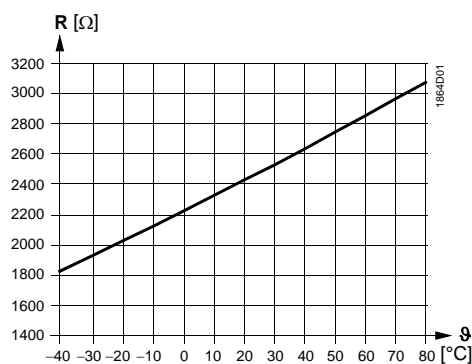
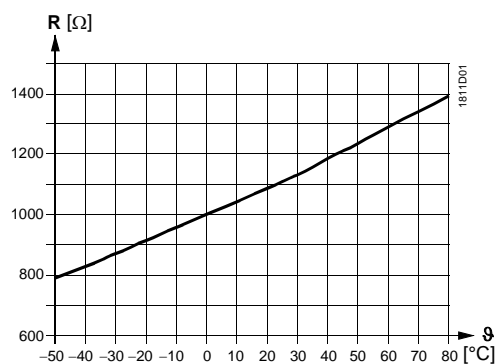

Legend

R Resistance value in Ohm
 θ Temperature in degrees Celsius

Mechanical design

The units have been designed for wall mounting. They are suitable for use with most commercially available recessed conduit boxes. The cables can be introduced from the rear (concealed wiring) or from below or above (surface-run wires) through knock-out openings.

The units consist of two major sections: Casing and baseplate. Both snap together but can be detached again.

The measuring circuit, the sensing elements and the setting element are located on the printed circuit board inside the casing.

The baseplate carries the connecting terminals.

Setting element

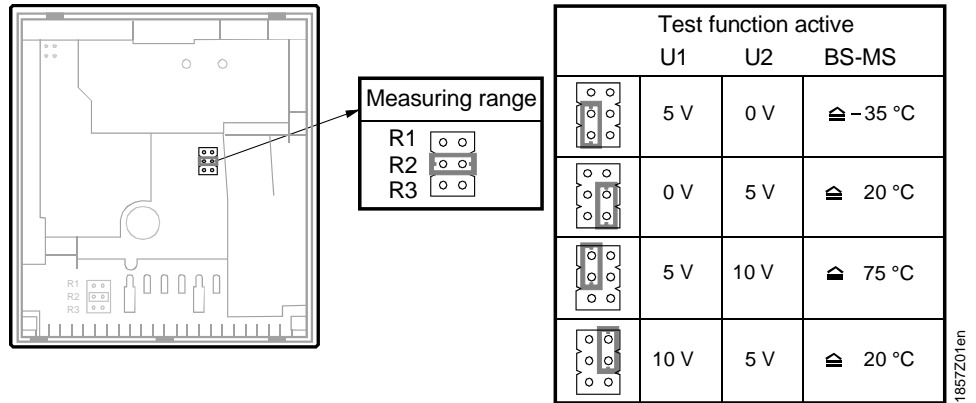

The setting element is accessible after removing the baseplate. It consists of 6 pins and a shorting plug. It is used to select the required measuring range and to activate the test function.

The different plug positions have the following meaning

- *For the passive temperature measuring range:*
Shorting plug in the mid position (R2) = LG-Ni 1000 or T1
- *For the activating temperature measuring range:*
Shorting plug in the upper position (R1) = -35...+35 °C,
Shorting plug in the mid position (R2) = 0...50 °C (factory setting),
Shorting plug in the lower position (R3) = 0...50 °C
- *For activating the test function:*
Shorting plug in the vertical position: The values according to the table "Test function active" will be made available at the signal output.

Fault

- Should the temperature sensor become faulty, there will be after 60 seconds a voltage of 0 V at signal output U2 or signal output BS-MS $\hat{=}$ -35 °C, and the humidity signal at signal output U1 will reach 10 V
- Should the humidity sensor become faulty, there will be a voltage of 10 V at signal output U1 after 60 seconds, and the temperature signal will remain active

Engineering notes

To power the sensor, a transformer for safety extra low-voltage (SELV) with separate windings for 100 % duty is required. When sizing and protecting the transformer, the local safety regulations must be observed.

When sizing the transformer, the power consumption of the room sensor must be taken into consideration.

For correct wiring of the sensor, refer to the Data Sheets of the devices with which the sensor is used.

The permissible line lengths must be observed.

Cable routing and cable selection

When laying the cables, it must be observed that the longer the cables run side by side and the smaller the distance between them, the greater the electrical interference.

Shielded cables must be used in environments with EMC problems.

Twisted pair cables are required for the secondary supply lines and the signal lines.

Fitting notes

Location

On an inner wall of the space to be air conditioned. Not in recessed, shelves, not behind curtains, not opposite or near heat sources.

The unit must not be exposed to spot lights or direct solar radiation.

The end of the conduit at the sensor must be sealed to prevent false measurements due to draughts through the conduit.

Installation instructions

Installation instructions are printed on the packing.

Commissioning notes

Check wiring before switching on power. The temperature measuring range must be selected on the sensor, if required.

Wiring and the output signals can be checked by making use of the test function (refer to "Mechanical design").



We recommend not to use voltmeters or ohmmeters directly at the sensing element. In the case of the simulated passive output signals, measurements with commercially available metres cannot be made (measuring current too small).

Technical data

Power supply	Operating voltage	AC 24 V \pm 20 % or DC 13.5...35 V
	Frequency	50/60 Hz at AC 24 V
	Power consumption	\leq 1 VA
Cable lengths for measuring signal	Perm. cable lengths	refer to Data Sheet of the device handling the signal
Functional data of humidity sensor	Range of use	0...95 % r. h. (non-condensing)
	Measuring range	0...100 % r. h.
	Measuring accuracy at 23 °C and AC 24 V	
	0...95 % r.h.	\pm 5 %
	30...70 % r.h.	\pm 3 %, typically
	Temperature dependency	\leq 0.1 % r. h./°C
	Time constant	2 min
	Perm. air velocity	20 m/s
	Output signal, linear (terminal U1)	DC 0...10 V \cong 0...100 % r. h., max. \pm 1 mA
	Functional data of temperature sensor with QFA2060	Range of use
Measuring range		0...50 °C / -35...+35 °C
Sensing element		NTC 10 k Ω
Measuring accuracy at		
15...35 °C		\pm 0.8 K
-35...+50 °C		\pm 1 K
Time constant		8 min (depending on air movement and thermal coupling to the wall)
Output signal, linear (terminal U2)		DC 0...10 V \cong 0...50 °C / -35...+35 °C max. \pm 1 mA
Functional data of temperature sensor with QFA2020, QFA2040	Measuring range	0...50 °C
	Sensing element simulated, corresponding to	
	QFA2020	LG-Ni 1000
	QFA2040 (serie B or higher)	T1 (PTC)
	Measuring accuracy at	
	15...35 °C	\pm 0.8 K
	-35...+50 °C	\pm 1 K
Time constant	8 min (depending on air movement and thermal coupling to the wall)	
Perm. measuring current with	QFA2020	1.18...3.29 mA
	QFA2040	0.53...1.46 mA
Degree of protection	Housing	IP 30 to IEC 529
	Safety class	III to EN 60 730
Electrical connections	Screw terminals for	1 \times 2.5 mm ² oder 2 \times 1.5 mm ²

Environmental conditions	Operation to	IEC 721-3-3
	Climatic conditions	class 3K5
	Temperature (housing with electronics)	-15...+50 °C
	Humidity	0...95 % r. h (non-condensing)
	Mechanical conditions	class 3M2
	Transport to	IEC 721-3-2
Materials and colors	Climatic condition	class 2K3
	Temperature	-25...+70 °C
	Humidity	<95 % r. h.
	Mechanical conditions	class 2M2
	Housing front	ASA + PC, NCS S 0502-G (white)
	Bottom section of housing	ASA + PC, NCS 2801-Y43R (grey)
Standards	Base	PC, NCS 2801-Y43R (grey)
	Sensor (complete assembly)	silicon-free
	Packaging	corrugated cardboard
	Product safety	
	Automatic electrical controls for household and similar use	EN 60 730-1
	Electromagnetic compatibility	
Weight	Immunity	EN 61 000-6-1
	Emissions	EN 61 000-6-3
	CE conformity to	EMC directive 89/336/EEC
	● conformity to	
	Australian EMC framework	Radio Communication Act 1992
	Radio Interference Emission Standard	AS/NZS 3548
Incl. packaging	approx. 0.13 kg	

Internal diagram

QFA2060

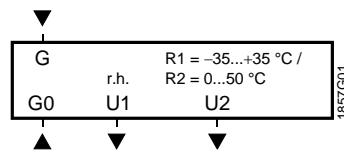

QFA2020, QFA2040 (serie B or higher)

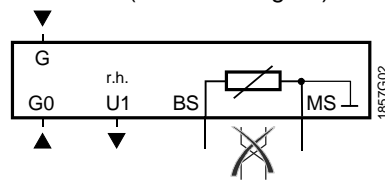

QFA2000

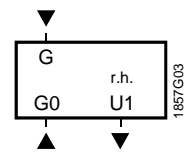

- G, G0 Operating voltage AC 24 V (SELV) or DC 13.5...35 V
 U1 Signal output DC 0...10 V for relative humidity 0...100 %
 U2 Signal output DC 0...10 V for temperature range 0...50 °C (R2 = factory setting) or -35...+35 °C
 BS, MS Signal output LG-Ni 1000 oder T1 (passive, simulated) for temperature range 0...50 °C; the wires must not be interchanged

Dimensions

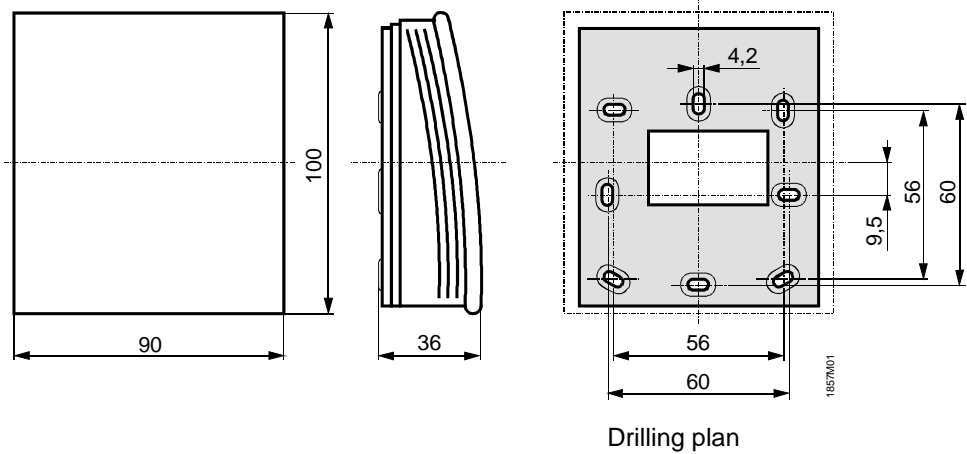

Dimension in mm