



Rotary actuators for ball valves

GDB..9E
GLB..9E

for ball valves VAI61.. and VBI61..

AC 24 V / AC 230 V

**Electromotoric rotary actuators for 3-position and modulating control,
pre-wired with 0.9 m long connection cables.**

Remarks

This data sheet provides a brief overview of these rotary actuators. Please refer to the Technical Basics in document Z4634en for a detailed description as well as information on safety, engineering notes, mounting and commissioning.

Use

- For 2-port and 3-port threaded ball valves from DN15 to DN50
- Suitable for use with modulating controllers (DC 0...10 V) or 3-position controllers

Type summary

	GDB/GLB131.9E	GDB/GLB331.9E	GDB/GLB161.9E
Operating voltage AC 24 V	X		X
Operating voltage AC 230 V		X	
3-position	X	X	
Positioning signal Y = DC 0...10 V			X
Position indicator U = DC 0...10 V			X
Self-adaption of rotational angle range			X
Rotary direction switch			X

Functions

Type	GDB/GLB131.9E / GDB/GLB331.9E	GDB/GLB161.9E
Control type	3-position control	Modulating control
Rotary direction	<p>Clockwise or counter-clockwise direction depends..</p> <p>..on the type of control. With no power applied, the rotary actuator remains in the respective position.</p> <p>..on the setting of the rotary direction DIL switch clockwise / counter-clockwise</p>	
	NC (normally closed) ball valve	NC (normally closed) ball valve
	Signal on Y1 – rotation counter-clockwise – ball valve opens Signal on Y2 – rotation clockwise – ball valve closes	DIL 2 set to “counter-clockwise” Flow = 0% at Y = 0 V Flow = 100% at Y = 10 V
	NO (normally open) ball valve	NO (normally open) ball valve
	Signal on Y2 – rotation clockwise – ball valve closes Signal on Y1 – rotation counter-clockwise – ball valve opens	DIL 2 set to “clockwise” Flow = 100% at Y = 0 V Flow = 0% at Y = 10 V
Position indication: Mechanical	Rotary angle position indication by a position indicator/hand lever.	
Position indication: Electrical		Output voltage U = DC 0...10 V is generated proportional to the rotary angle. U depends on the rotary direction of the DIL switch setting.
Manual adjustment	The rotary actuator can be manually adjusted by pressing the gear train disengagement button.	

Equipment combinations

The rotary actuators are suitable for operation of the following Siemens 2-and 3-port ball valves:

VAI61..		VBI61..		Rp	DN	PN class	GDB..9E		GLB..9E		Data sheet
Type	k_{vs} [m ³ /h]	Type	k_{vs} [m ³ /h]				Δp_{max}	Δp_s	Δp_{max}	Δp_s	
VAI61.15..	1...10	VBI61.15..	1.6...6.3	Rp ½"	15	PN40	350	1400	350	1400	N4211
VAI61.20..	4...10	VBI61.20..	4...6.3	Rp ¾"	20						
VAI61.25..	6.3...16	VBI61.25..	6.3...10	Rp 1"	25						
VAI61.32..	10...25	VBI61.32..	10...16	Rp 1¼"	32				350*/240**	1000	
VAI61.40..	16...40	VBI61.40..	25	Rp 1½"	40				350*/240**	800	
VAI61.50..	25...63	VBI61.50..	40	Rp 2"	50				350*/240**	600	

* VAI61.32-10/16, VAI61.40-16, VAI61.50-25 **VAI61.32-25, VAI61.40-25/40, VAI61.50-40/63

* VBI61.15...VBI61.40-16

**VBI61.40-25, VBI61.50-40

Notes

For more details about these rotary actuators see document Z4634.

Mounting

Both ball valve and rotary actuator can easily be assembled at the mounting location. Neither special tools nor adjustments are required.

The rotary actuator is supplied with Mounting Instructions 74 319 0646 0

The ball valve is supplied with Mounting Instructions 74 319 0647 0

Orientation

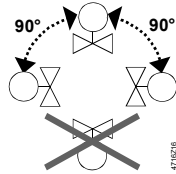

Commissioning





When commissioning the system, check wiring and the functions of the rotary actuator.

Manual adjustment

The rotary actuator can be manually adjusted into any position between 0° and 90° by pushing the gear train disengagement slider.

If a control signal from the controller is present, this will take priority in determining the position after the slider is released.

Technical data GDB..9E / GLB..9E

 AC 24 V supply (SELV/PELV)	Operating voltage / Frequency		AC 24 V \pm 20 % / 50/60 Hz
	Power consumption	GDB131.9E/GLB131.9E	Running 2 VA / 1 W
		GDB161.9E/GLB161.9E	Running 3 VA / 2 W Holding 1 W
 AC 230 V supply	Operating voltage / Frequency		AC 230 V \pm 10 % / 50/60 Hz
	Power consumption	GDB331.9E/GLB331.9E	Running 2 VA / 1 W
	Function data		Nominal torque 5 Nm (GDB) / 10 Nm (GLB) Nominal rotary angle / Max. rotary angle 90° / 95° \pm 2° Runtime for 90° rotary angle (GDB/GLB) 150 s (50 Hz) / 125 s (60 Hz)
Positioning signal for GDB161.9E/GLB161.9E	Input voltage Y (wires 8-2)		DC 0...10 V
	Max. permissible input voltage		DC 35 V, internally limited to DC 10 V
Position indicator for GDB/GLB161.9E	Output voltage U (wires 9-2)		DC 0...10 V
	Max. output current		DC \pm 1 mA
Connection cable	Cross-section		0.75 mm ²
	Standard length		0.9 m
Degree of protection of housing	Degree of protection as per EN 60 529 (note mount. instructions)		IP54
Protection class	Insulation class		EN 60730
	AC 24 V		III
	AC 230 V		II
Environmental conditions	Operation / Transport		EN 60721-3-3 / EN 60721-3-2
	Temperature		-32...+55 °C / -32...+70 °C
	Humidity (non-condensing)		< 95% r. h. / < 95% r. h.
Standards and directives	Product safety: Automatic electrical controls for household and similar use		EN 60730-2-14 (Type 1)
	Electromagnetic compatibility (EMC):		
	Immunity		IEC/EN 61000-6-2
	Emission		IEC/EN 61000-6-3
	 Conformity: Electromagnetic compatibility		2004/108/EC
		Low voltage directive	2006/95/EC
	 Conformity: Australian EMC Framework		Radio Communication Act 1992
	Radio Interference Emission Standard	AS/NZS 3548	
Weight	Without packaging:		0.75 kg

Disposal

The document on technical basics Z3634en and the environmental declaration provide information on environmental compatibility and disposal of this device.

Internal diagrams

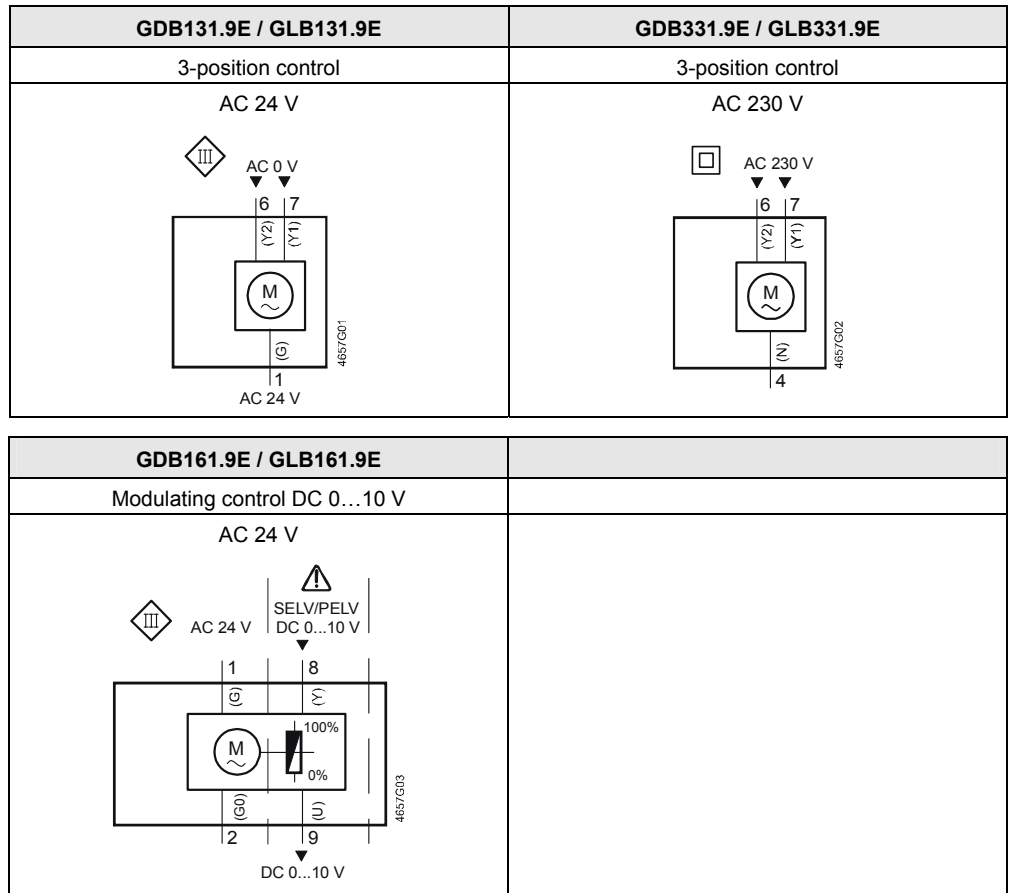

Cable labeling

Connection	Cable				Meaning
	Code	No.	Color	Abbreviation	
Rotary actuator AC 24 V	G	1	red	RD	System potential AC 24 V
	G0	2	black	BK	System neutral
	Y1	7	orange	OG	Positioning signal AC 0 V, counter-clockwise
	Y2	6	purple	VT	Positioning signal AC 0 V, clockwise
	Y	8	grey	GY	Positioning signal DC 0...10 V
	U	9	pink	PK	Position indication DC 0...10 V
Rotary actuator AC 230 V	N	4	blue	BU	Neutral conductor
	Y1	7	white	WH	Control signal AC 230 V, counter-clockwise
	Y2	6	black	BK	Control signal AC 230 V, clockwise

Dimensions

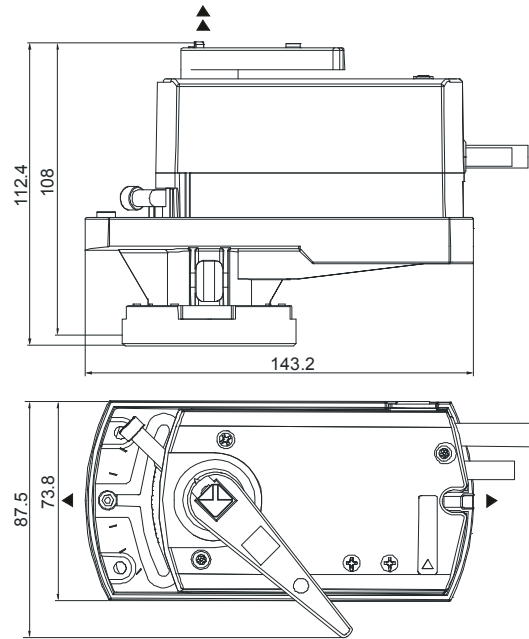

- ▶ = > 100 mm
- ▶▶ = > 200 mm

Minimum clearance from ceiling or wall for mounting, connection, operation, maintenance etc.

Dimensions in mm