



3-port seat valves, external thread, PN16

VXG44..

- Bronze CC491K (Rg5) valve body
- DN 15..DN 40
- k_{vs} 0.25..25 m³/h
- Flat sealing connections with external thread G...B to ISO 228-1
- Sets of ALG..3 screwed fittings with threaded connection available from Siemens
- Manual adjustment by means of mounted knob
- Can be equipped with SQS.. actuators

Use

In small or medium-sized heating, ventilating and air conditioning plants as a control valve for mixing and diverting functions.
For closed circuits only.

Type summary

Type reference	DN	k_{vs} [m ³ /h]	S_v
VXG44.15-0.25	15	0.25	> 50
VXG44.15-0.4		0.4	
VXG44.15-0.63		0.63	
VXG44.15-1		1	
VXG44.15-1.6		1.6	
VXG44.15-2.5		2.5	
VXG44.15-4		4	
VXG44.20-6.3	20	6.3	> 100
VXG44.25-10	25	10	
VXG44.32-16	32	16	
VXG44.40-25	40	25	

DN = Nominal size

k_{vs} = Nominal flow rate of cold water (5...30 °C) through the fully open valve (H_{100}) by a differential pressure of 100 kPa (1 bar)

S_v = Rangeability k_{vs} / k_{vr}

k_{vr} = Smallest k_v value, at which the flow characteristic tolerances can still be maintained, by a differential pressure of 100 kPa (1 bar)

Accessories

Type	Stock No.	Description
ALG..3	ALG..3	Set of 3 screwed fittings for 3-port valves, consisting of - 3 union nuts, 3 discs and 3 flat seals ALG..3B are brass fittings, for media temperatures up to 100 °C.
ALG..3B	S55846-Z1..	

Order

When ordering please give quantity, product name and type reference.

Example:

Type	Stock No.	Description	Quantity
VXG44.25-10	VVG44.25-10	3-port seat valve	1
ALG253B	S55846-Z105	Set of screwed fittings	1

Delivery

Valves, actuators and accessories are packed and supplied separately.

Spare parts, rev. no.

See overview, page 7.

Equipment combinations

Valves	Actuators SQS..		Fitting sets		
	Δp_{\max} mixing [kPa]	Δp_{\max} diverting ¹⁾ [kPa]	Malleable cast iron Type/Stock no.	Threaded Brass ²⁾ Type Stock No.	
VXG44.15-0.25	400	100	ALG153	ALG153B	S55846-Z101
VXG44.15-0.4					
VXG44.15-0.63					
VXG44.15-1					
VXG44.15-1.6					
VXG44.15-2.5					
VXG44.15-4					
VXG44.20-6.3	75	ALG203	ALG203B	S55846-Z103	
VXG44.25-10					
VXG44.32-16					
VXG44.32-16	250	50	ALG323	ALG323B	S55846-Z107
VXG44.40-25	125	35	ALG403	ALG403B	S55846-Z109

¹⁾ If noise is permitted, the same values apply as for mixing

²⁾ Media temperature: maximum 100 °C

Δp_{\max} = Maximum permissible differential pressure across valve's control path, valid for the entire actuating range of the motorized valve

Actuator overview

Type reference	Operating voltage	Positioning signal		Positioning time	Spring return		Datasheet
SQS35.00	AC 230 V	3 position		150 s	no		N4573
SQS35.03				35 s			
SQS35.50				150 s	yes	8 s	
SQS35.53				35 s			
SQS65.5	AC 24 V	DC 0...10 V	0...1000 Ω	35 s	yes	8s	
SQS65		DC 2...10 V		no			
SQS65.2		3 position				150 s	
SQS85.00						35 s	
SQS85.03							

Technical design / mechanical design

Valve cross section

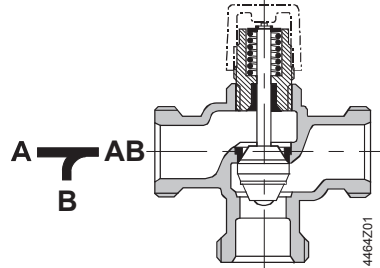

- Guided parabolic plug (from DN25) which is attached to the valve stem.
- The seat is fitted in the through-port and attached directly to the valve body in the bypass.
- From DN25, the seat in the through-port is attached directly to the valve body and fitted to the ring in the bypass.

Sizing

Flow diagram

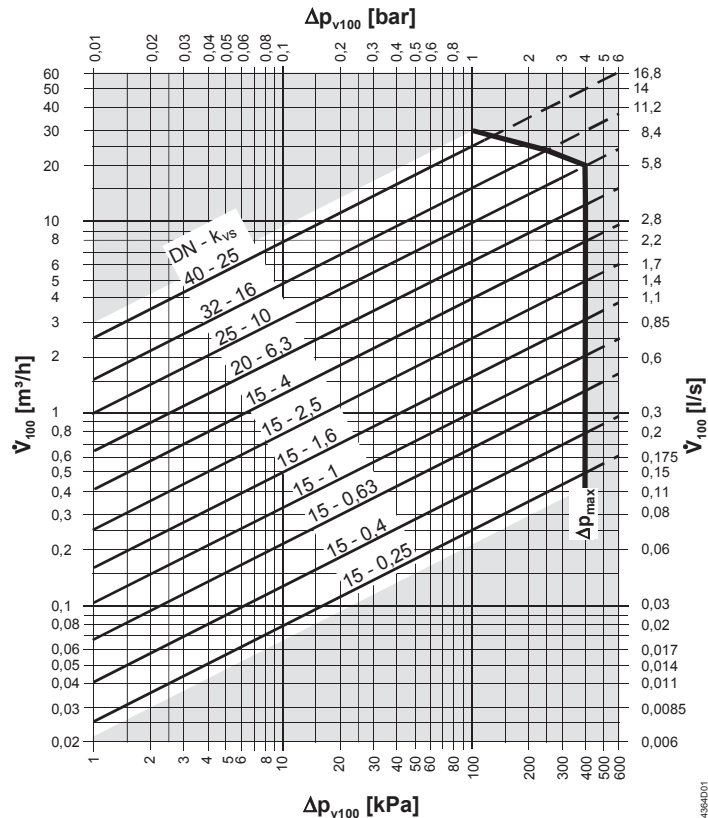

Δp_{max} = Maximum permissible differential pressure across the valve (mixing: port A - AB, B - AB), valid for the entire actuating range of the motorized valve

Δp_{v100} = Differential pressure across the fully open valve and the valve's control path A - AB, B - AB by a volume flow V_{100}

\dot{V}_{100} = Volume flow through the fully open valve (H_{100})

100 kPa = 1 bar \approx 10 mWC

1 m³/h = 0.278 l/s water at 20 °C

Valve flow characteristic

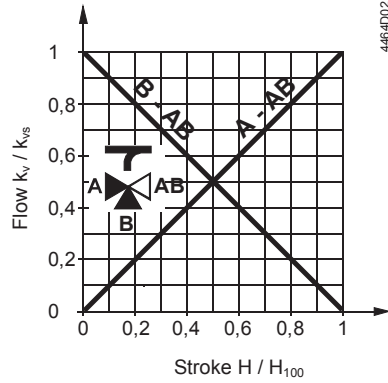

Valve flow characteristic:

Through-port: linear as per VDI /VDE2173
 Bypass: linear as per VDI /VDE2173

Mixing:

Flow from port A and port B to port AB

Diverting:

Flow from port AB to port A and port B

Port A = variable flow

Port B = Bypass (variable flow)

Port AB = constant flow

Use the three-port valve primarily as a mixing valve.

Working pressure and temperature

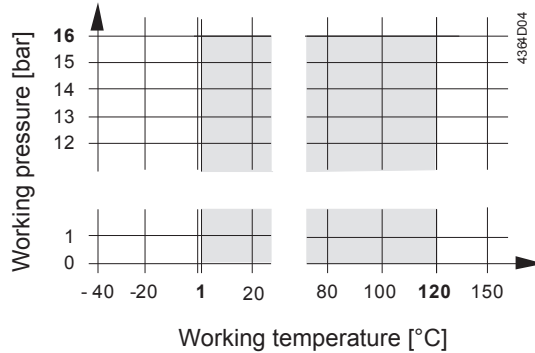

Working pressure and medium temperature staged as per ISO 7005

Current local legislation must be observed.

Notes

Engineering

Always use a strainer upstream of the valve to increase the valve's functional safety.

Mounting

Both valve and actuator can easily be assembled at the mounting location. Neither special tools nor adjustments are required.

The valve is supplied with Mounting Instructions 4 319 9564 0.

Orientation

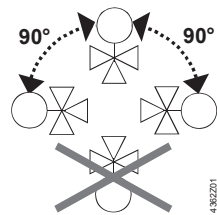

Direction of flow

When mounting, pay attention to the valve's flow direction symbol:

- Mixing from A / B to AB
- Diverting from AB to A / B



Commissioning



Commission the valve only if the actuator has been mounted correctly.

Valve stem retracts: Through-port A – AB opens, Bypass closes

Valve stem extends: Through-port A – AB closes, Bypass opens

Maintenance

VXG44.. valves require no maintenance.

Warning

When doing service work on the valve / actuator:

- Deactivate the pump and turn off the power supply
- Close the shutoff valves
- Fully reduce the pressure in the piping system, allow pipes to completely cool down
If necessary, disconnect the electrical wires.

Before putting the valve into operation again, make certain the actuator is correctly fitted.

Stem sealing gland

The stem sealing gland cannot be exchanged. In the case of leakage, the entire valve must be replaced. Contact your local office or branch.

Disposal



Before disposal the valve must be dismantled and separated into its various constituent materials.

Legislation may demand special handling of certain components, or it may be sensible from an ecological point of view.

Current local legislation must be observed.

Warranty

The technical data given for these applications is valid only in conjunction with the Siemens actuators as detailed under "Equipment combinations".

All terms of the warranty will be invalidated by the use of actuators from other manufacturers.

Technical data

Functional data	PN class	PN 16 to ISO 7268	
	Operating pressure	to ISO 7005 within the permissible medium temperature range according to the diagram on page 4	
	Flow characteristic 0...100 %	linear to VDI / VDE 2173 (through-port and bypass)	
	Leakage rate	0...0.02 % of k_{vs} value to DIN EN 1349 (through-port and bypass)	
	Permissible media	chilled water, low temperature hot water, water with anti-freeze. recommendation: water treatment to VDI 2035	
	Medium temperature ¹⁾	1...120 °C	
	Rangeability S_v	DN 15: > 50 resp. > 100, refer to "Type summary" DN \geq 20: >100	
	Nominal stroke	5.5 mm	
	Industry standards	Pressure Equipment Directive	PED 97/23/EC
		Pressure Accessories	as per article 1, section 2.1.4
Fluid group 2		without CE-marking as per article 3, section 3 (sound engineering practice)	
Environmental compatibility		ISO 14001 (Environment) ISO 9001 (Quality) SN 36350 (Environmentally compatible products) RL 2002/95/EG (RoHS)	
Materials		Valve body	bronze CC491K (Rg5)
	Seat in the through-port	stainless steel, bronze Rg5 or brass	
	Seat in the bypass	bronze Rg5 or brass	

5/8

Dimensions / Weight	Plug	stainless steel or brass
	Stem	stainless steel
	Sealing gland	brass
	gland materials	EPDM O rings
	Refer to "Dimensions"	
	External thread connections	G..B to ISO 228-1
Actuator connection	G $\frac{3}{4}$ "	

¹⁾ With ALG..B fittings for media temperature up to 100 °C

Dimensions

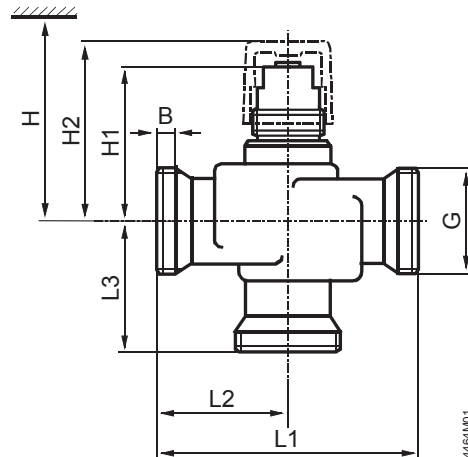

- DN = Nominal size
H = Total actuator height plus minimum distance to the wall or the ceiling for mounting, connection, operation, service, etc.
H1 = Dimension from the pipe centre to install the actuator
H2 = Pipe centre to upper edge of manual adjustment button, valve in «closed» position

Type reference	DN	B [mm]	G [Inch]	L1 [mm]	L2 [mm]	L3 [mm]	H1 [mm]	H2 [mm]	H SQS..	Weight [kg]			
VXG44.15-0.25	15	8.5	G 1B	100	50	50	45	55	> 364	0.5			
VXG44.15-0.4							49	59			0.59		
VXG44.15-0.63												53	63
VXG44.15-1									68	78			
VXG44.15-1.6												71	81
VXG44.15-2.5							77.5	87.5	> 389	1.74			
VXG44.15-4											80.5	90.5	> 392
VXG44.20-6.3	20	9	G 1½B	105	52.5	52.5	68	78	> 379	0.90			
VXG44.25-10	25	11	G 1½B				71	81	> 382	1.30			
VXG44.32-16	32		G 2B	77.5	87.5	> 389	1.74						
VXG44.40-25	40		G 2¼B	130	65	65	80.5	90.5	> 392	2.39			

Fittings

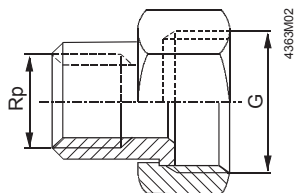

Type/Stock no.	Type	Stock no.	for valve type	G [Inch]	Rp [Inch]
ALG153	ALG153B	S55846-Z101	VXG44.15..	G 1	Rp ½
ALG203	ALG203B	S55846-Z103	VXG44.20	G 1¼	Rp ¾
ALG253	ALG253B	S55846-Z105	VXG44.25	G 1½	Rp 1
ALG323	ALG323B	S55846-Z107	VXG44.32	G 2	Rp 1¼
ALG403	ALG403B	S55846-Z109	VXG44.40	G 2¼	Rp 1½

- On valve side: cylindrical thread to ISO 228-1
- On pipe side: with cylindrical thread to ISO 7-1
- ALG..B for media temperatures up to 100 °C

Spare parts

Type	Stock No.	Description	Quantity
74 676 0273 0	74 676 0273 0	Manual knob for short stroke valves	10

Revision numbers

Type	Valid from rev. no.	Type	Valid from rev. no.	Type	Valid from rev. no.
VXG44.15-0.25	..01	VXG44.15-1.6	..01	VXG44.25-10	..01
VXG44.15-0.4	..01	VXG44.15-2.5	..01	VXG44.32-16	..01
VXG44.15-0.63	..01	VXG44.15-4	..01	VXG44.40-25	..01
VXG44.15-1	..01	VXG44.20-6.3	..01		

